



INSPECTION REPORT
1303 Central Manor Rd
Washington Boro, PA 17582
Nancy Jenkins
04/08/2024



Inspector
Matthew Haughery
Matthew Haughery
ASHI, #267507
717-808-5997
Bill@PreciseInspecting.com



Agent
Renee Weaver
HK Keller

TABLE OF CONTENTS

1: Inspection Details	6
2: Roofing	7
3: Exterior	11
4: Interiors	22
5: Structural Components	28
6: Insulation and Ventilation	35
7: Heating	39
8: Air Conditioning	40
9: Plumbing	42
10: Electrical	51
11: Utility Locations and Shut-offs	61
12: Built-in Appliances	63
13: Scope and Limitations	68
14: Environmental Concerns	71
15: Checklist	72
Standards of Practice	73

NAVIGATING THE REPORT

Thank you for choosing **Precise Inspecting** to inspect your home! Please carefully read your entire Inspection Report. If you have any questions throughout the closing process please don't hesitate to ask. I am here to help make your home purchase as pleasant as possible. Happy reading!



OVERVIEW - This tab gives a quick summation of the areas inspected, not inspected, not present, or defective.

INFORMATION - This tab is the descriptive section of the report in which you will find all the general information required by the ASHI Standards of Practice. It includes all the general photos of the property, including roofs, attics, crawlspaces and any thermal images.

LIMITATIONS - This tab is an important section that highlights the areas of the home that could not be inspected because they were not visible or accessible at the time of inspection. Please read in full the limitations sections. In most instances, there are important recommendations that should be followed in order to protect you from unseen defects in the home.

STANDARDS - This tab consists of the ASHI Standards of Practice broken down by its general category.

It is important that you act on the defects, safety issues and recommendations of this entire report, including the Summary and the Limitations sections. Furthermore is important that you do this prior to the end of your inspection contingency period so that you can be fully aware of the nature and cause of the issues noted in this report. The evaluation by a professional may discover additional problems that are not visible at the time of the inspection and that require repairs. The opinions of these professionals are an important supplement to this report.

SUMMARY



MAINTENANCE



RECOMMENDATIONS











MATERIAL DEFECTS

SUMMARY

1) Material Defects - This category is composed of "material defects" as defined by the state of Pennsylvania. Specifically it refers to "a problem with a residential real property or any portion of it that would have a significant adverse impact on the value of the property or that involves an unreasonable risk to people on the property." They consist of systems, structures, or components that are broken, not working as intended, not installed properly, of immediate safety concern, or have a significant adverse impact on the property's value. **It is important that these items should be addressed by a qualified contractor prior to the end of your contingency agreement.**

2) Recommendations - Recommendations refer to components that are functional at the time of the inspection but require a qualified contractor to evaluate further, in order to determine life expectancy or if repairs or replacements are necessary. Also included in this category are mechanical and structural systems nearing the end of their useful life but still working. Items in this category may or may not be defective. I recommend that these items be addressed by a qualified contractor prior to the end of your contingency agreement.

3) Maintenance - These observations are primarily comprised of maintenance items and are provided in order to draw attention to items that need attention or repair by a professional before they develop into significant problems.

-  3.1.1 Exterior - Walkways: Walkway settlement
 -  3.4.1 Exterior - Grading and Drainage: Grading - Low spot(s)
 -  3.7.1 Exterior - Decks: Multiple Deck Defects
 -  3.16.1 Exterior - Vegetation: Tree(s) too close to structure
 -  4.3.1 Interiors - Walls: Wall damage
 -  4.5.1 Interiors - Floors: Missing carpet
 -  4.10.1 Interiors - Steps, Stairways & Railings: Open stair railing
 -  4.11.1 Interiors - Fire Separation: Fire separation - missing at walls
-

-
- 🔧 5.1.1 Structural Components - Attic, Roof and Ceiling Structure: Moisture stain from past leak
 - ⚠️ 5.5.1 Structural Components - Foundation Structure: Moisture penetration
 - 🚫 6.3.1 Insulation and Ventilation - Exhaust Systems: Radon - Test recommended
 - 🚫 6.3.2 Insulation and Ventilation - Exhaust Systems: Bath exhaust - recommended
 - 🚫 9.6.1 Plumbing - Water Heater: Electric water heater nearing end of useful life
 - ⚠️ 10.2.1 Electrical - Main Distribution Panel: Shared neutral wires
 - ⚠️ 10.2.2 Electrical - Main Distribution Panel: Missing(open) knockout(s)
 - 🔧 10.4.1 Electrical - Connected Devices and Fixtures: Missing fixture
 - 🚫 10.5.1 Electrical - Receptacles : GFCI outlet(s) protection missing
 - 🔧 10.5.2 Electrical - Receptacles : Receptacle - Cover Plate missing
 - 🚫 10.7.1 Electrical - Fire/CO Safety: Recommend replace all fire/CO safety devices
 - ⚠️ 12.6.1 Built-in Appliances - Washer/Dryer: Potential leak

1: INSPECTION DETAILS

Information

Front Elevation



Right Side Elevation



Rear Elevation



Left Side Elevation



Temperature and Weather



Year built

1974

Square Footage

2200

Type

Single Family, Detached

In Attendance

Client, Client's Agent

Style

Split-level

Your home's life expectancy

[Home Material Life Expectancy](#)

Occupancy

Furnished, Occupied

Where the home is furnished there will be certain limitations to the home inspection. These limitations are spelled out in the [ASHI Standard of Practice](#) which provides the guide for this home inspection.

2: ROOFING

		IN	NI	NP	C
2.1	Coverings	X			
2.2	Flashings	X			
2.3	Roof Drainage Systems	X			
2.4	Venting	X			
2.5	Skylights, Chimneys & Roof Penetrations	X			

IN = Inspected NI = Not Inspected NP = Not Present C = Comments

Information

Venting: Type

Ridge vent, Soffit vents, Gable vent

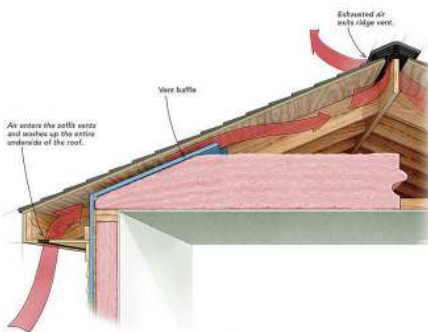

Ventilation Illustration

Coverings: Type

Asphalt architectural 30 yr

At the time of the inspection, it was not possible to determine the life expectancy of the entire roof because I was not able to determine 1) the roof material manufacturer, 2) the exact installation method, or 3) the date of installation. Climate and regular maintenance also affect longevity. In addition, some roofs with multiple coverings have been installed at different times meaning leaks can occur as the coverings age differently over time.

All of these are factors in determining a roof's life expectancy. It is important to have a qualified professional regularly inspect the roof in order to more accurately anticipate a roof replacement. I highly recommend you research the roof material of your roof in order to better determine it condition and serviceable life. This is the only way to obtain an accurate assessment of a roof's life expectancy.

How Long Does a Roof Last?



Clemens Home Solutions



Coverings: Roof inspection method

Walked roof

The inspector will make every effort to inspect all accessible roof surfaces and materials. The inspector is not required to access roofs that, in his judgment, are unsafe to traverse or may result in damage to the roofing materials (i.e. slate, tile, etc.)

In other cases, conditions on the day of inspection may make certain areas of the roof inaccessible, not visible, or obstructed from view. When these conditions are present the roof will not be fully inspected. Hidden damage may exist. In these cases, a qualified roofing contractor should evaluate the roof prior to settlement.

At times a drone can be used to visually inspect the roof. It is not required. The preferred method of inspecting a roof is to physically access the roof but if the roof is too steep or the materials are brittle and susceptible to breaking when walked on a drone may be used. While drones are good at accessing difficult-to-reach portions of the roof (like tops of chimneys) they are not able to feel brittle surfaces or spongy roof conditions. Drone photography falls outside the requirements of a home inspection and its inclusion has limitations as stated above. Where these limitations exist it is recommended that a licensed, professional roofing contractor be contacted to evaluate the overall condition of the roof prior to settlement.

Coverings: Roof Photos



Flashings: Material

Aluminium

At the time of the inspection the roof flashings appeared to be functional. Not all flashing is visible due to the siding and shingles that cover it. Any defects will be listed separately in the report.

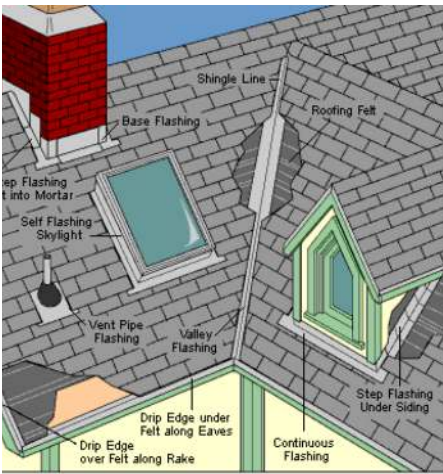

Various Types of Roof Flashing

Roof Drainage Systems: Gutter and Downspout material

K style, Aluminium, w/ gutter guards

At the time of the inspection the gutter and downspouts appeared to be functional. I recommend periodic cleaning to maintain open flow of water.

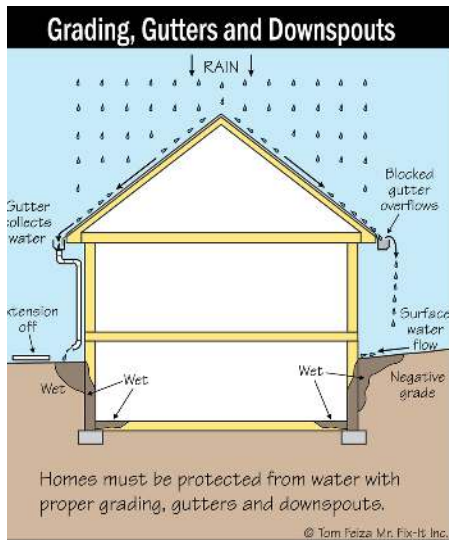

15B.C

Skylights, Chimneys & Roof Penetrations: Roof Penetrations

Plumbing vent PVC

Rubber boots systems have a limited life expectancy and can fail without warning. I recommend a qualified professional to evaluate these connections yearly to check for deterioration and to replace before a roof leak develops.

Skylights, Chimneys & Roof Penetrations: Chimney Type

None

Masonry products, including stucco and adhered masonry, tend to absorb and hold moisture. This moisture will then dry inwards and can carry that moisture into the interior structure. I recommend periodic examination of the structure on the inside in order to verify that moisture intrusion is not occurring.

Skylights, Chimneys & Roof Penetrations: Skylights

None

Skylights are popular architectural features in homes, on both flat (low-sloped) and sloped (steep) roofs. They may be single-, double- or triple-glazed, and they may have flat or curved glazing. Skylights may be installed on curbs, or they may be flush mounted. Most templates are manufactured units, but they also may be site-built.*

Older and less expensive skylights were often installed without a curb and step flashing. These skylights are often acrylic and sealed to the roof with a mastic/adhesive. Because this type of skylight cannot accommodate seasonal expansion and contraction, the mastic often fails and leaks result.

*See [Skylights](#)

3: EXTERIOR

		IN	NI	NP	C
3.1	Walkways	X			X
3.2	Driveways	X			
3.3	Porches, Balconies, Steps and Railings	X			
3.4	Grading and Drainage	X			X
3.5	Foundation Wall Exterior	X			
3.6	Siding	X			
3.7	Decks	X			X
3.8	Service Entrance Conductors and Grounding	X			
3.9	Exterior Doors	X			
3.10	Flashing & Trim	X			
3.11	Eaves, Soffits & Fascia	X			
3.12	Outside A/C unit	X			
3.13	Exterior Hose Bibs	X			
3.14	Exterior Venting	X			
3.15	Exterior Paint	X			
3.16	Vegetation	X			X
3.17	Fire Escape/Emergency Egress	X			
3.18	Other items present		X		

IN = Inspected NI = Not Inspected NP = Not Present C = Comments

Information

Walkways: Material

Slate, Brick

Driveways: Material

Asphalt

Porches, Balconies, Steps and Railings: Type

Front stoop, Rear Porch, Side patio

Porches, Balconies, Steps and Railings: Material

Pavers, Concrete

Siding: Material

Vinyl, Brick

Siding: Siding Style

Veneer, Clapboard

Decks: Type and Material

Rear deck, Treated wood, Enclosed

Service Entrance Conductors and Grounding: Type and Voltage

Conduit, 200 amp



Outside A/C unit: Residential AC typical diagram

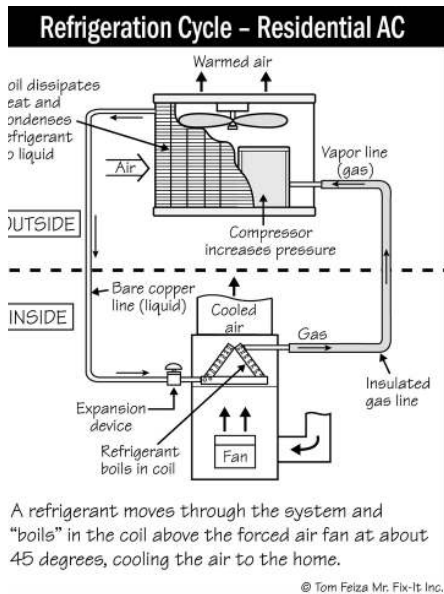

032 Conventional AC

Exterior Hose Bibs: Type Freeze protection

Fire Escape/Emergency Egress: Emergency Exit



Life expectancy of exterior components

Note: Life expectancy of exterior building materials varies with installation, maintenance, and quality of materials. The link below includes a general guideline for life expectancy for common building materials.

[Standard Estimated Life Expectancy Chart for Homes](#)

Grading and Drainage: Drainage Type

Exterior Foundation

Downspout to grade

The proper diverging of rain water away from the house is a crucial aspect of keeping foundations and basements dry. It is recommended that all surface drains be directed at least 4 feet away from the foundation any underground drainage pipes are not within the scope of this home inspection I recommend their non-visible sections and all outlets be investigated prior to settlement by a qualified professional.

Important note: the interior of downspouts and underground drains cannot be visually inspected and may contain hidden defects such as clogged gutters or holes not visible. I highly recommend a thorough inspection of the downspouts prior to settlement. Consider a video scope inspection.

Article on [Proper Drainage](#)

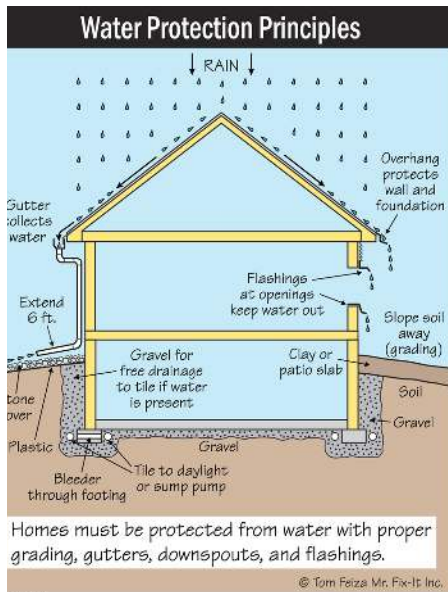

© Tom Feiza Mr. Fix-It Inc.

Grading and Drainage: Direction

Neutral

Definitions:

Positive - At the time of the inspection, the grading around the house appeared to be sloped away from the house to allow for proper drainage of rainwater. Any specific recommendations will be mentioned in the report below.

Neutral - At the time of the inspection, I observed grading against the house that could potentially collect water and create an avenue for moisture to enter the home. Neutral grades should be inspected regularly in order to access if they are adequate in directing water away from the house. Any specific recommendation will be mentioned in the report below.

Negative - At the time of the inspection, I observed a negative grading against the house that could potentially collect water and create an avenue for moisture to enter the foundation. Negative grading should be addressed ASAP as damage to the structure can result quickly. Specific conditions and recommendations are mentioned in comments below.

Prevent basement water problems

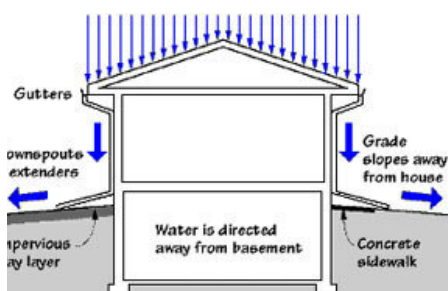

Foundation Wall Exterior: Type

Concrete block

Foundation walls are an important structural component of a home. However they are vulnerable to water penetration at all times. It is important to know that not all walls perform the same with regards to moisture penetration into the basement or crawlspace. Even if a wall is structurally sound it may transfer moisture into the interior. Older hand laid stone walls can be very porous and will allow water to enter the interior space easily. Brick or concrete block wall are less porous but still are vulnerable to moisture penetration, especially during heavy rain. Poured concrete and Superior wall systems provide greater protection against moisture penetration but are still vulnerable.

Please note carefully the type of foundation wall system noted here. In all types care must be taken to regularly examine the exterior grading and roof spouting surrounding the foundation to avoid unnecessary water entering the basement or crawlspace.

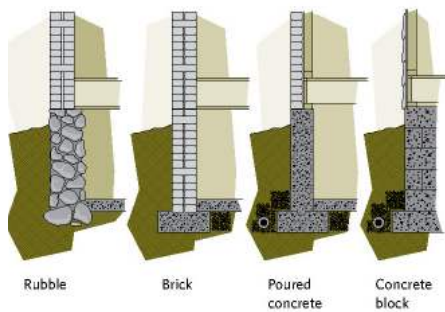

Most common in Pennsylvania

Decks: Important Deck Comments

Important note: An exterior wooden residential deck has a limited lifespan. Because it is regularly exposed to the stresses of climate and usage, at some point it will fail. Caution should be taken to periodically inspect the entire deck after settlement. This inspection report is not a code inspection of the deck components. Because of this, I recommend using a qualified deck construction professional.

We further recommend that the professional be familiar with code compliances in a nationally recognized standard such as the [DAC6](#).



Service Entrance Conductors and Grounding: Entrance

Overhead

At the time of the inspection the service conductors appeared to be in good condition. Any defects will be listed separately in the report.

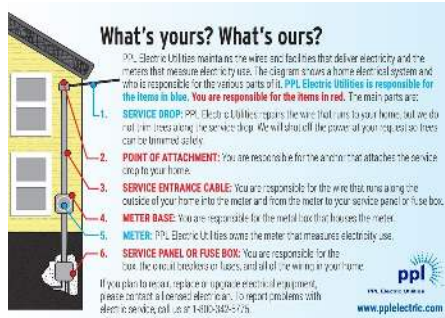

Utility Responsibility



Service Entrance Conductors and Grounding: Grounding method

Two copper ground rods

Grounding is a method of giving electricity the most effective way to return to the ground through the service panel. When the electricity is on, current flows from the panel to the outlet or device to power it up. The neutral wire is the return path for unused current. The ground wire is an additional path for electrical current to return safely to the ground without danger to anyone in the event of a short circuit.



Exterior Doors: Types

Garage door, Single Swing, Sliding Glass

All exterior doors were inspected for proper functioning, safety, and any materials defects. Electric garage door openers were tested for safety features including either electronic eyes or pressure sensitive closures.

Exterior Doors: Material

Steel, Steel and glass, Vinyl

At the time of the inspection the exterior entry door appeared to be in good condition. Any recommendations will be listed separately in the report.

Flashing & Trim: Material

Aluminium

At the time of the inspection, the flashing and trim appeared to be in good condition. Any recommendations will be listed separately in the report.

Eaves, Soffits & Fascia: Material

Aluminium

The **eaves** are the edges of the roof which overhang the face of a wall and, normally, project beyond the side of a building. The eaves form an overhang to throw water clear of the walls. The **soffit** is the underside of the eave whereas the fascia is the outward-facing vertical portion. Under ideal circumstances, the air flow depicted in the diagram below should be present. If not you may want to consider upgrading the ventilation system. The **fascia** is the vertical face of the roof edge that covers the roof rafters. It is usually positioned behind the gutter.

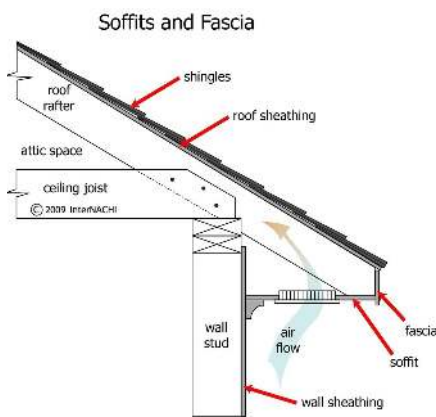

Ideal circumstances

Outside A/C unit: Exterior AC unit and age

2022 Year

Compressor age



Exterior Venting: Exterior dryer vent

Rear

The dryer vent allows for moisture and lint to exit the house. It should be regularly maintained. If not it can become a fire hazard*. In order to prevent a possible fire, I recommend periodic cleaning.

If the dryer vent cap was visible and within reach, I inspected the opening. If it was not visible or within reach (see limitation section), I recommend this be inspected prior to settlement and become part of regular home maintenance afterward.

See limitation comments in this section for further information.

*Dryer vent piping that becomes clogged is a leading cause of house fires.

[How to Clean Dryer Vents](#)



Exterior Paint: Lead Paint

****Safety Concern**** - Any home built before 1978 may have lead paint somewhere unless it was completely gutted and rebuilt. This is not an inspection for lead based paint. See note under environmental concerns.

Vegetation: Trees and shrubs

Present and partially maintained

A home inspection includes making an assessment of vegetation that comes into contact with the home. Plants and branches, even at full growth, should be kept 12-18 inches away from house siding, roof, and windows. Keep the trees and their roots away from the foundation. Plants or trees in contact or in close proximity to the home can provide pathways for wood destroying insects to enter the house and can damage the exterior walls, windows, roofs, and foundations.

Article on [landscaping](#) and your house

Other items present: Storage Shed

Rear

At the time of inspection I observed a detached exterior storage shed. Storage sheds are not part of the home inspection unless added to invoice.



Other items present: Fire Pit

At the time of the inspection, the property there was a fireplace or fire pit present. Inspection of this item falls outside the scope of a home inspection.



Limitations

Foundation Wall Exterior

FOUNDATION WALL NOT COMPLETELY VISIBLE

At the time of inspection the foundation wall was not completely visible from the exterior. Hidden damage may exist. I recommend a qualified professional to evaluate the condition of the exterior foundation wall at this location.

Outside A/C unit

OUTSIDE TEMPERATURE TOO LOW

The A/C unit was not tested because the outside temperature was below 65. Operating the unit may cause damage the unit. The condition of the system could not be determined. I recommend a thorough evaluation be given by a qualified HVAC professional prior to settlement.

Comments

3.1.1 Walkways

WALKWAY SETTLEMENT

2 LOCATIONS



****Safety Hazard**** At the time of the inspection I observed a portion of the exterior walkway that was settling. This creates an uneven surface that is not safe to walk over. If not repaired further settlement and cracking will occur. I recommend a qualified professional to repair.



Walkway



Edge of patio

3.4.1 Grading and Drainage



Recommendations

GRADING - LOW SPOT(S)

RIGHT SIDE

At the time of the inspection there was a potential low spot(s) around the foundation wall. The depressed area(s) creates a pathway for water to enter the home causing water damage. I recommend this area(s) be evaluated and re-graded to avoid this potential entry point.



Right Side

3.7.1 Decks



Material Defects

MULTIPLE DECK DEFECTS

The deck was functional but had the following notable defects, missing lateral load connectors, missing joist hangers, insufficient lag fasteners, Lag bolts missing

****Safety Issue**** I observed multiple deck defects. See individual photo descriptions. These defects represent various structural and/or safety issues and should be evaluated by a professional using the [DAC6](#) code. The current condition of the deck is not safe and in most cases a complete rebuild of the deck may be the most cost effective option.

I recommend consulting a qualified deck contractor AND the national code standard [DAC6](#) so that a thorough evaluation of the deck can be made against current deck construction codes followed by professional recommendations.



Beam support not adequate

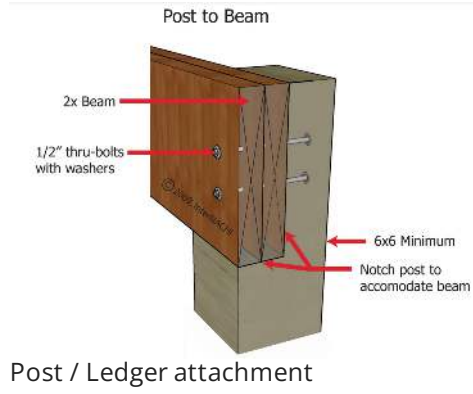

Post / Ledger attachment

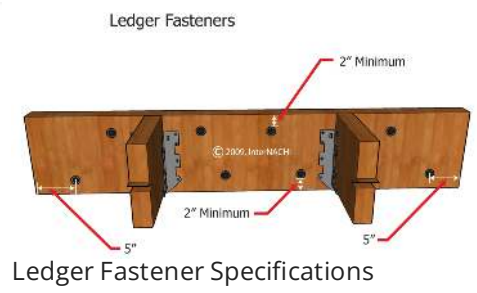

Ledger Fastener Specifications

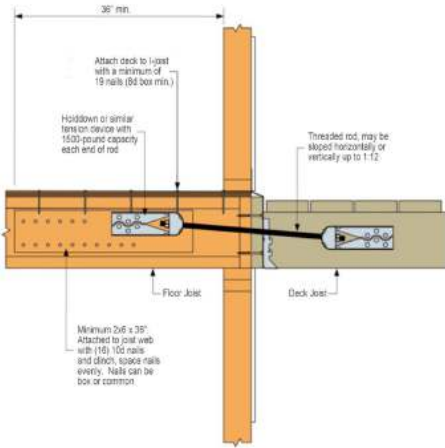

Lateral Load Connectors



Lateral load connectors missing

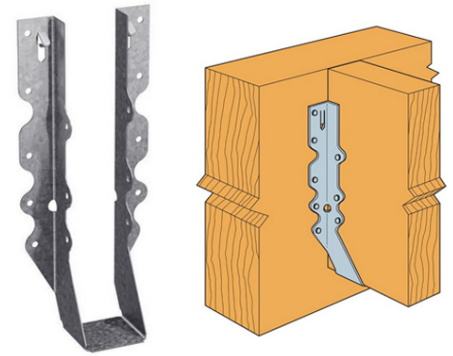

Joist hanger



Joist hangers missing at house



Joist hangers missing at rim joist

3.16.1 Vegetation

 Recommendations**TREE(S) TOO CLOSE TO STRUCTURE**

REAR PORCH

At the time of the inspection there was at least 1 tree(s) that was growing too close to the house. Potential damage to the structure may result, especially from high winds, if this tree is not removed. I recommend a qualified professional to make recommendations for trimming or removal.



4: INTERIORS

		IN	NI	NP	C
4.1	Interior Photos	X			
4.2	Ceilings	X			
4.3	Walls	X			X
4.4	Windows	X			
4.5	Floors	X			X
4.6	Doors	X			
4.7	Countertops & Cabinets	X			
4.8	Paint	X			
4.9	Interior trim	X			
4.10	Steps, Stairways & Railings	X			X
4.11	Fire Separation	X			X
4.12	Emergency Egress	X			

IN = Inspected NI = Not Inspected NP = Not Present C = Comments

Information

Interior Photos: Garage Photos
Photos



Ceilings: Ceiling Material
Plaster, Suspended Ceiling
Panels

Floors: Floor Covering
Tile, Vinyl

Countertops & Cabinets:
Cabinetry Material
Wood, Composite

Countertops & Cabinets:
Countertop Material
Granite

Emergency Egress: Status

Present and functional



Interior areas not inspected

****Important Note**** At the time of inspection there were areas such as, but not limited to, walls, ceilings, floors, mechanical components, plumbing fixtures, slabs and other parts of the home that **were not inspected because access and visibility was limited**. See [ASHI SOP Sec.13](#). Prior to settlement and after the area is made accessible Precise Inspecting will return to inspect the area for a fee.

Interior components

Throughout

During the home inspection a representative sample of multiple components will be inspected. The inspector will make every effort to observe all visible components and comment on them, however not every window, door, switch, outlet, valve or faucet will be checked. Furthermore, where stored items, furniture and equipment are present visibility is limited to what can be seen without moving items. As a result, certain components cannot be inspected. It may be prudent to return for a re-inspection after these items are removed.

Interior Photos: 1st Floor Photos

Photos



Interior Photos: Basement

Photos



Walls: Wall Material

Plaster

At the time of the inspection the walls appeared to be in good condition. Any defects will be listed separately in the report.

Windows: Window material

Vinyl

The life expectancy of windows can be 20-40 years depending upon materials, climate conditions and manufacturer. See charts of averages below.

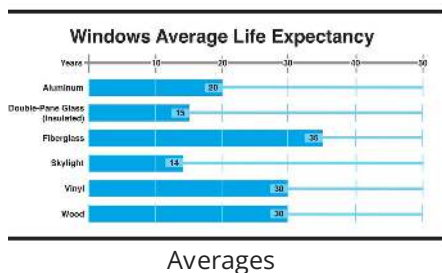

Windows: Window Type

Thermal, Double-hung, Stationary

At the time of the inspection the windows appeared to be in good condition. Any defects will be listed separately in the report. Any storm windows present were not inspected as they are not included in an ASHI home inspection.

Doors: Type

Hollow Core flush

At the time of the inspection the interior doors appeared to be in good condition. Any recommendations will be listed separately in the report.

Paint: Lead Paint

Various possible locations

Any home built before 1978 may have lead paint somewhere unless it was completely gutted and rebuilt. This is not an inspection for lead based paint. See note under environmental concerns.

Fire Separation: Between Garage and House

Garage

Inadequate

For **fire safety** all walls, ceilings, doors and hatches should be rated for 1 hour separation between the garage and living space.

Limitations

Windows

STORM WINDOWS AND SCREENS NOT INSPECTED

The inspection of storm windows and window screens are not included in an ASHI home inspection. See the ASHI Standards of practice in this section marked "Standards".

Doors

STORM DOORS NOT INSPECTED

The inspection of storm doors are not included in an ASHI home inspection. See the ASHI Standards of practice in this section marked "Standards".

Comments

4.3.1 Walls

WALL DAMAGE

BASEMENT

I observed damage to an interior wall. See photo description. I recommend repair by a professional.



Maintenance



4.5.1 Floors

MISSING CARPET

THROUGHOUT MAIN FLOOR



Material Defects

I found an area of carpet that was missing. I recommend this be installed by a professional.

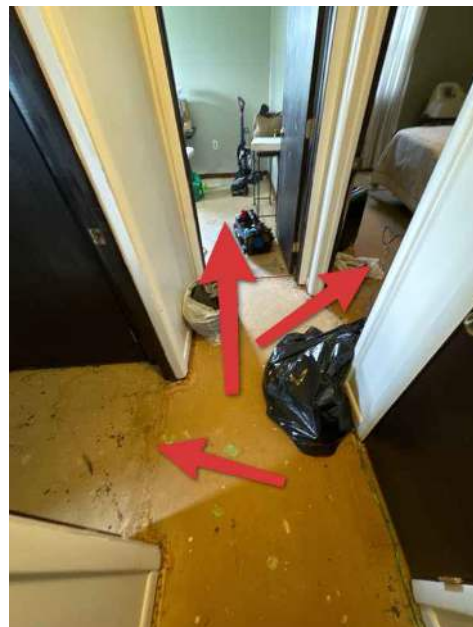

4.10.1 Steps, Stairways & Railings

OPEN STAIR RAILING

BASEMENT STAIRS

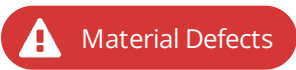

****Safety Issue**** - At the time of the inspection I found a stairway that had openings in the railing(s). Adequate spacing at railings protect against falls (think children and elderly). The spacing must be 4-3/8" between rails or balusters. Install necessary railings and/or balusters in order to make this stairway safe.

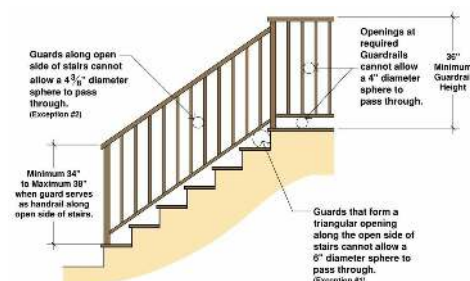

Illustration



4.11.1 Fire Separation

FIRE SEPARATION - MISSING AT WALLS

GARAGE/LIVING SPACE

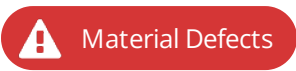

At the time of the inspection a fire-separated wall and/or ceiling between the garage and living space was not completely present. Municipal code in, newer construction, requires that the garage be separated from the dwelling unit and attic with a material that meets fire separation codes. These codes may not have been in effect during construction of this property. I recommend a qualified professional to evaluate and upgrade to ensure compliance with local codes.

Note: In most cases 5/8" drywall that is properly taped and mudded will fulfill this requirement.



50670



5: STRUCTURAL COMPONENTS

		IN	NI	NP	C
5.1	Attic, Roof and Ceiling Structure	X			X
5.2	Wall and Ceiling Structure	X			
5.3	Basement	X			
5.4	Floor Structure	X			
5.5	Foundation Structure	X			X

IN = Inspected NI = Not Inspected NP = Not Present C = Comments

Information

Attic, Roof and Ceiling Structure:
Attic structure and material
 Dimensional wood, Plywood

Wall and Ceiling Structure:
Material
 Wood

Floor Structure: Material
 Wood dimensional



Foundation Structure: Type
 Full basement

Attic, Roof and Ceiling Structure: Inspection Method
 Attic
 Attic entered

I made a good faith effort to inspect the attic and its structural components (framing, sheathing, and insulation). An inspector is not required to traverse attic load-bearing components that are concealed by insulation or by other materials or to enter areas that are only accessible through an opening less than 16" x 24".

Attic, Roof and Ceiling Structure: Attic Photos

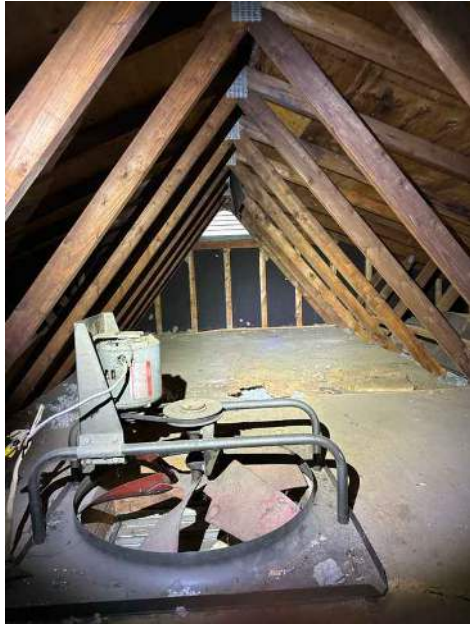

Attic, Roof and Ceiling Structure: Deck/porch Attic Photos



Wall and Ceiling Structure: Wall framing inaccessible.

Overall

Walls appeared to be constructed properly, however, the materials used could not be inspected because of interior and exterior coverings. Hidden damage may exist.

Basement: Basements

Basement

Maintaining your basement is the single most important homeowner responsibility. You will want to correct and maintain grading, gutters, downspouts, sump pump discharge and all sources of surface water.

For **safety** reasons, all basement level living spaces should have 2 exits or means of egress. In the event of a fire or other emergency, this allows two escape routes. In some situations, a large window can provide this exit. If you plan on using a basement level as living space you should check with your local fire department for safety precautions.

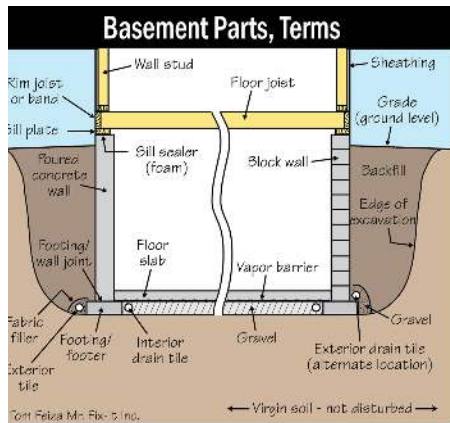

107C

Foundation Structure: Material

Masonry block

At the time of the inspection the structure of the home appeared to be in good condition. Any defects will be mentioned specifically in the report. It should be noted that stone, brick and concrete block foundations are considered "porous" and will easily allow moisture to pass for the outside to the inside. This is an informational comment. If moisture is visible at the time of inspection it will be noted in a separate comment below with photos.

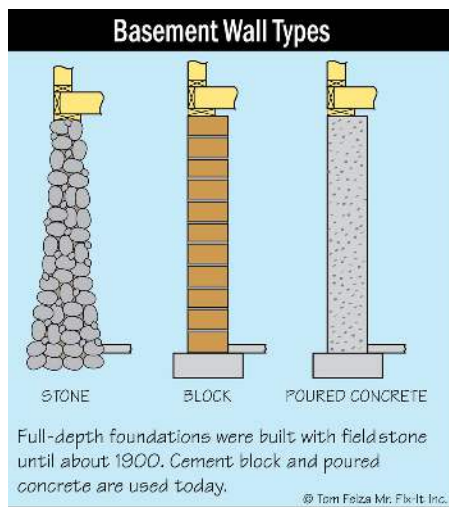

157C

Limitations

Attic, Roof and Ceiling Structure

ATTIC, ACCESS LIMITED

ATTICS AND KNEE WALLS

Access to some parts or all of the attic above the ceiling and knee walls was limited (cathedral ceilings would be one example). As a result, I was not able to fully inspect this area. Hidden material defects may exist including moisture issues. For further information on the limitations of inspecting attics with limited access see [ASHI SOP](#)

Basement

BASEMENT, LIMITED OR NO ACCESS

BASEMENT WALLS



Basements are one of the most vulnerable areas of a home or property for several reasons.

1. It's proximity to moisture from both the outside and inside.
2. Important mechanical components are located here such as electrical, HVAC, and especially plumbing.
3. The location of critical structural components.

Although every effort is made to thoroughly inspect the basement, when access is limited or none nonexistent a thorough inspection cannot be made. Some examples would be:

1. Areas blocked by stored items.
2. Generally cluttered conditions.
3. Wall and ceiling coverings including suspended ceilings.
4. Insulation
5. Areas out of reach with limited visibility.

Hidden damage may exist. It is recommended that arrangements be made for access prior to settlement so that a qualified professional can inspect these areas.

Floor Structure

VIEW OF FLOOR STRUCTURE LIMITED OR INACCESSIBLE

When, at the time of the inspection, most or all of the floor structure in the home is inaccessible a complete inspection of the floor structure is not possible. Hidden damage may exist. Some examples are:

1. Slab on grade construction.
2. Ceiling and wall coverings.
3. Inaccessible rooms or crawlspaces.
4. Stored items that obstruct views.

It is recommended that arrangements be made for access prior to settlement so that a qualified professional can inspect these areas.



Foundation Structure

LIMITED OR NO VISIBILITY

BASEMENT WALLS



Not all of the main structural components of the property's foundation were visible at the time of inspection. A General Home Inspection does not include an evaluation of structural components that are hidden. This includes areas behind insulation, floor, wall, and ceiling coverings or where access is restricted because of stored items. An inspector is not required to enter areas where opening are small or that he deems to be unsafe. Where these conditions are present hidden damage may exist that requires a separate inspection by a qualified professional.

Comments

5.1.1 Attic, Roof and Ceiling Structure



MOISTURE STAIN FROM PAST LEAK

REAR DECK ATTIC

The area pictured here was stained from a past moisture leak. I recommend monitoring to make sure there are no future issues.

NOTE: This corner was difficult to get to and I was not able to confirm the moisture level of the wood.



Close up



Moisture stain in corner of roof valley

5.5.1 Foundation Structure



MOISTURE PENETRATION

BASEMENT LAUNDRY ROOM

Moisture appeared to be entering the foundation. See photos. Most moisture problems originate on the exterior. If the source is not identified, this moisture can cause significant damage. I recommend the exterior be evaluated in order to determine where the water is coming from and so repairs can be made to stop future water penetration.



Wet reading on meter



Moisture at base of wall



Moisture soaking through trim



Moisture, extending into adjacent room

6: INSULATION AND VENTILATION

		IN	NI	NP	C
6.1	Insulation Unfinished Areas	X			
6.2	Attic Ventilation	X			
6.3	Exhaust Systems	X			X
6.4	Vapor Barriers		X		

IN = Inspected NI = Not Inspected NP = Not Present C = Comments

Information

Insulation Unfinished Areas: Type

Blown, Fiberglass



Attic maintenance

Attic

All attic areas should be reviewed at least twice per year to ensure ventilation openings are clear and to ensure the development of mold is kept in check. Even if there is very little or no evidence of mold build-up in the attic at the time of inspection, it can reproduce and spread rapidly should conditions allow it to. Mold can be potentially hazardous and will spread when moisture enters the attic cavity and is not vented to the exterior. Any area of suspected mold should be reviewed by a qualified contractor for analysis and removal.

Attic Ventilation : Attic Ventilation Types

Ridge Vents, Soffit Vents, Gable Vents

Whenever possible, attics should have ventilation openings high (exhaust) on the ridge and low on the eave (intake). Rising warm air moves from the eaves to the ridge.

Exhaust Systems: Exhaust systems type

Dryer vent

An inspection of all visible exhaust fans and ducting was made. In cases where the exhaust system is inside walls, covered with insulation or otherwise not visible these components will not be inspected. Hidden damage may exist and a thorough inspection by a qualified professional is recommended.

Exhaust Systems: Ducting material

Not completely visible

Ducting material is a key component in moving harmful moisture from the home to the outside. The quality of the material used for this ductwork is important. See more info on [Ducting Material](#) as referenced in the picture below.



Types of exhaust ducting

Exhaust Systems: Radon mitigation system

If the home has a radon mitigation system installed this inspection falls outside the ASHI Standards of Practice, however Precise Inspecting can perform a 24 point mitigation system inspection as recommended by the Pennsylvania EPA for an additional fee.

IMPORTANT - The Environmental Protection Agency recommends radon testing every 2 years for homes that have an installed radon mitigation system present and every 5 years in homes that do not have a mitigation system but have levels below 4.0 Pci/l.

I recommend a PA DEP licensed professional perform a radon test in each separate structural zone per PA DEP guidelines. This test can be performed by [Precise Inspecting](#). We are licensed radon measurement specialists. If high levels of radon exist, mitigation should be performed by a separate licensed radon mitigation company.

PA DEP requires one radon test per [structural zone](#)

Please Read: [EPA's Home Buyers and Sellers Guide to Radon](#)

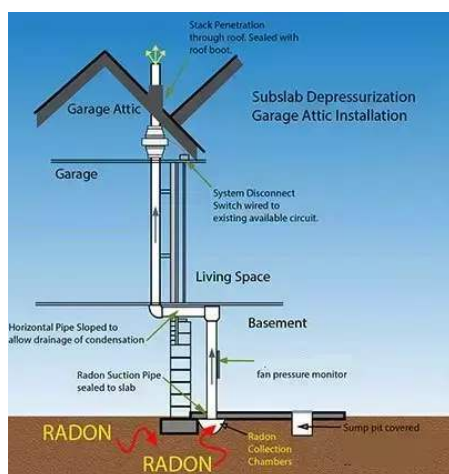

Typical system diagram

Exhaust Systems: Radon Mitigation System

Native

The inspector will identify whether an active, passive or native radon system is in place. An inspection of the system itself is not part of the ASHI home inspection SOP.

Passive refers to a pipe installed below the concrete and vented upwards and out of the house. This does not function as a radon gas removal system. **Active** refers to an active working Radon Mitigation system that is complete with an active fan. **Native** refers to no radon system of any kind present. **It is highly recommended by the EPA to retest radon levels in a home with an existing system every 2 years.**

See Home Buyers and Sellers Guide to Radon

<https://www.epa.gov/sites/production/files/2015-05/documents/hmbuygud.pdf>

Vapor Barriers: Vapor barrier in attic unknown

At the time of the inspection I could not determine if there was a vapor barrier separating the attic from the finished space below. A vapor barrier retards the transfer of moisture and gases into the house.

Limitations

General

INSULATION WILL NOT BE DISTURBED

ATTIC, WALLS, CEILINGS AND BASEMENTS

The visible insulation of the home will be inspected but not disturbed as per the ASHI Standards Of Practice. There may be hidden defects. In-depth inspection of the insulation and areas behind or beneath it should be evaluated by an insulating company or general contractor.

Comments

6.3.1 Exhaust Systems

RADON - TEST RECOMMENDED

BASEMENT

****Potential Health Hazard**** At the time of inspection a radon test was not performed. Radon is a class A carcinogen and the second leading cause of lung cancer in the USA. Not knowing your radon levels can be hazardous to your health.

The Environmental Protection Agency recommends radon testing

- every 2 years for homes that have an installed radon mitigation system and
- every 5 years in homes that do not have a mitigation system but have levels below 4.0 Pci/l.

I recommend a PA DEP licensed professional perform a radon test in each separate structural zone per PA DEP guidelines. This test can be performed by [Precise Inspecting](#). We are licensed radon measurement specialists. If high levels of radon exist, mitigation should be performed by a separate licensed radon mitigation company.

PA DEP requires one radon test per [structural zone](#)

Please Read: [EPA's Home Buyers and Sellers Guide to Radon](#)



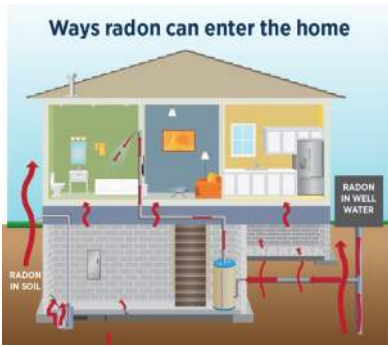

Radon entry points

- FLOOR-WALL JOINTS
- FLOOR CRACK AND CRAWL SPACE
- SUMP PIT
- SHOWER WELL WATER



6.3.2 Exhaust Systems

BATH EXHAUST - RECOMMENDED

Recommendations

BATHROOM

At the time of the inspection there was no exhaust fan in the bathroom. Exhaust fans help remove moisture from the room and avoid potential mold issues. Bathroom exhaust fans are not required if there is a window that opens to the outside. However, I recommend a professional mechanic install an exhaust fan in this room.

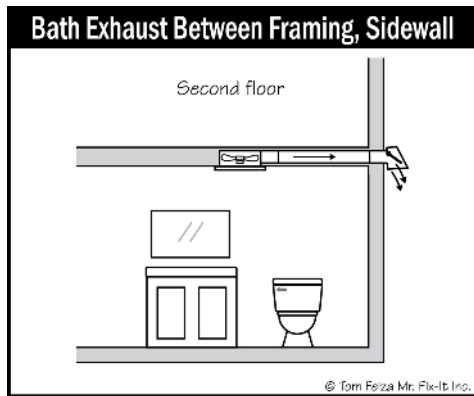

Optional installation #1



7: HEATING

		IN	NI	NP	C
7.1	Heat System	X			
7.2	Electric Heat	X			
7.3	Distribution Systems	X			

IN = Inspected NI = Not Inspected NP = Not Present C = Comments

Information

Electric Heat: Heat Type
Baseboard

Distribution Systems:
Distribution Type
Electric baseboard

Heat System: Electric Baseboard

Baseboard heaters contain electric heating elements. These elements usually have aluminum fins to aid heat transfer, which run the length of the baseboard heater's housing or cabinet. Some units are recessed into the wall.

As air within the heater is warmed, it rises into the room, and cooler air is drawn into the bottom of the heater.

Baseboard heaters are designed to envelop the room in warmth without using up a lot of electricity. This allows you to keep the central heating system turned down low during those colder evenings, and turn on your floor heater for more energy-efficient warmth.

Electric Baseboard Heater Wiring

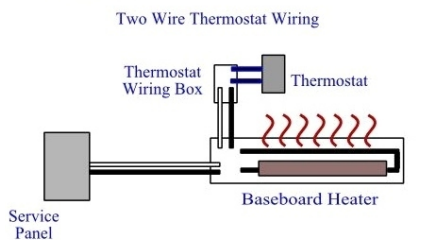
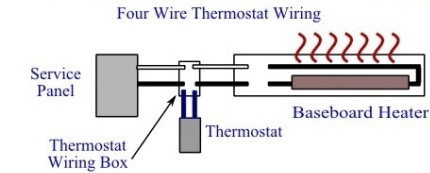

Typical electric baseboard heat system



8: AIR CONDITIONING

		IN	NI	NP	C
8.1	Cooling Equipment	X			
8.2	Distribution System	X			

IN = Inspected NI = Not Inspected NP = Not Present C = Comments

Information

Cooling Equipment: AC Interior Unit

Electric

Distribution System: Air Filter Washable

How an A/C system works

In its most basic description, the air conditioning process involves two actions that occur simultaneously, one inside the home and one outside the home.

Inside the home (sometimes referred to as the “cold side” of the system), warm indoor air is cooled as it blows across a cold cooling coil full of refrigerant. Heat from indoor air is absorbed into the refrigerant as the refrigerant turns from liquid to gas. The cooled air is distributed back to the house.

Outside the home (sometimes referred to as the “hot side” of the system), the refrigerant gas is compressed before entering a large coil in the outdoor unit. Heat is released outside as the refrigerant turns back to a liquid and a large fan pulls outdoor air through the outdoor coil rejecting the heat absorbed from the house.

The result is a continuous cycle of heat and humidity being removed from indoor air, cool air returning to the home, and heat and humidity exiting the home. ... [read more](#)

How an Air Conditioner Works:

Similar to how a refrigerator works, air conditioners transfer heat from a home's interior to the warm outside environment.

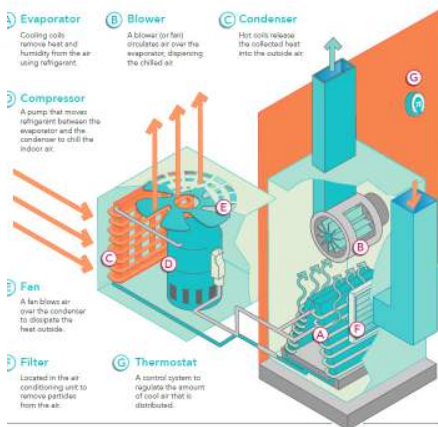

A/C system appeared satisfactory

See limitations this section. At the time of the inspection the A/C system was not tested because the outside temperature was below 65. Operating the unit, at low temperatures, may cause damage to the unit. I recommend a thorough evaluation by a qualified HVAC professional prior to settlement.

Note: See limitations in this section.

Cooling Equipment: Age

2022

Air conditioning systems require proper and regular maintenance in order to work efficiently. With proper care most components will last 15 to 20 years. If the unit is approaching the later end of its life, I recommend budgeting for a new unit.



Cooling Equipment: Regular maintenance recommended

At interior AC unit

Important: Cooling systems are complex and have many components and they are in need of regular service, repair and replacement in order for the systems to function efficiently. Filters should be changed regularly according to manufactures recommendations. During the home inspection a visual inspection was made of the cooling system (if the temperature was above 65°) to confirm its functionality. Many of the interior, non-visible parts will not be checked. I highly recommend a professional HVAC technician inspect this system prior to settlement or immediately after taking possession, in order to determine the future life expectancy of the system.

Distribution System: Type

insulated duct, Wall and floor cavities, flexible duct

At the time of the inspection, the ducting system appeared to be in good condition. All accessible supply ducts were checked for flow. Representative photos are show below. Any defects will be listed separately in the report.

Limitations

AC System

OUTSIDE TEMPERATURE RANGE

The A/C unit was not tested because the outside temperature was below 65. Operating the unit may cause damage the unit. The condition of the system could not be determined. I recommend a thorough evaluation be given by a qualified HVAC professional prior to settlement.

Cooling Equipment

OUTSIDE TEMPERATURE TOO LOW TO TEST

BELOW 65 DEGREES

The A/C unit was not inspected because the outside temperature was below 65. The oil used to lubricate the compressor is a weight that does not lubricate well when it is cold. Operating the unit may cause damage to the unit.

As a result the condition of the system could not be determined. I highly recommend a thorough evaluation be given by a qualified HVAC professional prior to settlement.

9: PLUMBING

		IN	NI	NP	C
9.1	Water Supply	X			
9.2	Water Distribution lines	X			
9.3	Toilets, Fixtures, Faucets	X			
9.4	Sinks, Tubs, Showers	X			
9.5	Drain, Waste, & Vent Systems	X			
9.6	Water Heater	X			X
9.7	Sump Pumps			X	
9.8	Fuel Supply, Storage & Distribution Systems	X			

IN = Inspected NI = Not Inspected NP = Not Present C = Comments

Information

Water Heater: Capacity

50 gal

Water Heater: Cold water supply valve

Present

Water Heater: Power Source

Electric

Water Supply: Main Water Supply Source

Public

The water supply appeared to be originating from this identified source however I recommend checking with the local municipality and the home owner in order to verify.

Water Supply: Main Water Pressure Regulator

At Main Water Meter

Present

A **water pressure regulator** is a specialized type of valve that reduces the incoming water pressure to a manageable level for the home plumbing infrastructure. Water pressure regulators are typically installed where the main water line enters the home, just after the main shutoff valve.

If the water pressure is too high, it can cause significant damage to the valves, faucets, appliances, pipes, and plumbing fittings. Water pressure regulators reduce stress on inner seals and connections within the water supply lines. This includes the inner workings of appliances like dishwashers, clothes washers, ice makers and more.

Most home plumbing fixtures are designed to work best at a pressure of about 50 psi (pounds per square inch), but it is not uncommon for municipal water supplies to enter the home with pressures as high as 150 or 200 psi. If such high pressure is present on a regular basis, the strain can eventually cause joints to fail, faucets and other fixtures to leak, and appliances to break down.

A qualified plumber can be consulted to determine if one should be installed (if one does not already exist).

For more information:

[Water Pressure Regulators](#)

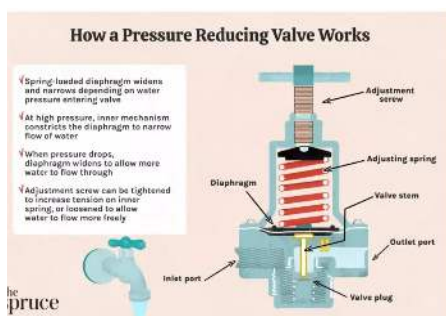

Illustration

Water Supply: Main Water Supply Material

Copper

Underground pipes or pipes inside walls cannot be judged for type of material, size, leaks, corrosion or other defects. Hidden damage may exist. I recommend these lines be evaluated by a licensed professional.

Water Supply: Secondary water source

None

The secondary water supply appeared to be originating from this identified source however I recommend this be verified by a qualified professional.

Water Supply: Water Testing Recommendations

Water testing and water treatment equipment was not evaluated as a part of this home inspection unless requested as an additional service. If there are any smells, deposits or quality issues noticed during your inspection, you should have the water tested or evaluated by a specialist. This would also include water treatment equipment.

All private well systems must be routinely maintained and tested for safety. If you have a well system that is used for watering grass only, your local municipality may still require routine checks. All well systems must be actively used or properly abandoned. Consult a professional in these systems for more information.

Water Supply: Auxilliary Water Systems

None

The presence and functionality of auxiliary water systems and are not part of this home inspection's standards of practice and were not evaluated. These systems require periodic maintenance. I recommend a complete evaluation by a licensed water treatment contractor.

Water Supply: Water Sensor Alarms

Consider installing water sensor alarms in areas susceptible to water damage due to plumbing leaks or pump failures (e.g. water heaters, boilers, sump baskets, clothes washers, dishwashers, and HVAC condensate drains). For more information on this topic, click here: [Automatic water leak protection](#)

Water Distribution lines: Water Distribution lines

Pex, CPVC

Visible water lines with unobstructed views were inspected. Many water lines are hidden in walls and/or inaccessible. These water lines may have damage that is hidden. I recommend a thorough inspection by a licensed professional prior to settlement.

Drain, Waste, & Vent Systems: DWV Type

Basement

See limitations, PVC

An inspection industry's standard drainage test for "functional drainage"* was performed on the drainage system.

The drain pipes appear operational at the time of inspection. I was not able to inspect drain lines that were hidden, nor was I able to confirm the condition of the inside of all drain lines. Hidden damage may exist. Only an invasive inspection or video-scope of the interior of the drain lines can fully confirm their actual condition.

****Caution**** Cast iron typically rusts from the inside out therefore its condition cannot be fully determined by a visual home inspection. Leakage that was not present or visible at the time of the inspection may occur when the home is occupied and water usage increases.

1. If usage (volume of waste water) of these drain lines increases when a new owner moves in, leaks can develop that were not present at the time of inspection.
2. If a home is vacant for several months or more, the inside of the cast iron can dry out and become detached from the drain wall. When water is introduced back into the drain lines the dry cast iron pieces can become detached from the drain line walls and clog the system.

Because of this, and other factors associated with cast iron, I recommend a qualified professional to inspect the cast iron lines prior to settlement and to consider a video scope.

Further problems may exist in homes that

- are vacant
- have older plumbing systems
- that have had past drain problems
- or have large trees on the grounds
- consult the seller for detailed information on these lines

**functional drainage means a drain is functional when it empties in a reasonable amount of time and does not overflow when another fixture is drained simultaneously.*

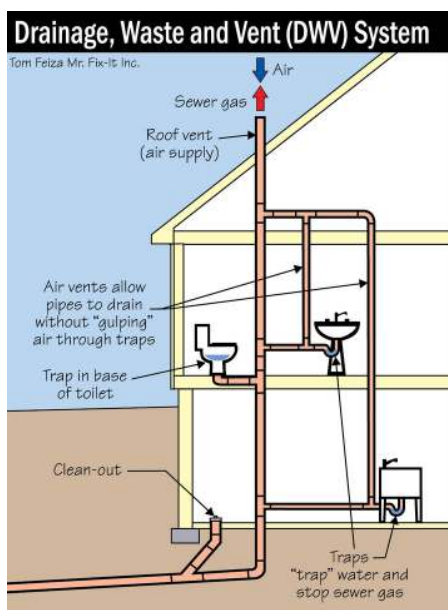

016

Drain, Waste and Vent systems

Drain, Waste, & Vent Systems: Sewer Line is not inspected

Basement

Inspection of the sewer line in the following areas is not within the scope of a home inspection (please see the Scope and Limitations section at the beginning of this report).

- behind walls
- beyond the foundation wall
- below the basement slab

Sewer lines, especially cast iron, clay tile or Orange-burg lateral lines, should be inspected regularly in order to ensure no obstructions are present.

I inspected the visible cast iron drain lines in the home's drain system. Some of these lines may be hidden behind walls or under floors or in crawlspaces. Cast iron typically rusts from the inside out therefore its condition cannot be fully determined by a visual home inspection. Leakage that was not present or visible at the time of the inspection may occur when the home is occupied and water usage increases.

1. If usage (volume of waste water) of these drain lines increases when a new owner moves in, leaks can develop that were not present at the time of inspection.
2. If a home is vacant for 6 months or more, the inside of the cast iron can dry out and become detached from the drain wall. When water is introduced back into the drain lines the dry cast iron pieces can become detached from the drain line walls and clog the system.

Because of this, and other factors associated with cast iron, I recommend a qualified professional to inspect the cast iron lines prior to settlement and to consider a video scope of the entire line all the way to the public connection.

Common Cast Iron Pipe Problems

I highly recommend a video inspection of the main sewer line (from the house to the street) be done by a qualified professional, using professional equipment, prior to settlement.

Sewer Inspections

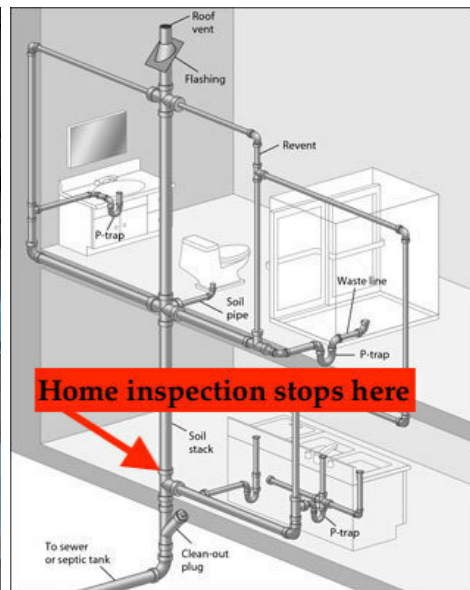

Home owner is responsible for soil line from house to street

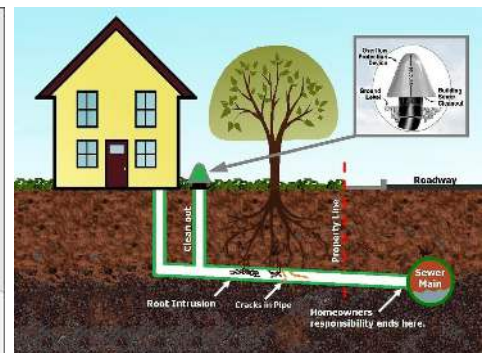

Typical public septic

Water Heater: Expansion tank

Present

A pressurized expansion tank is a sealed cylinder divided by a flexible diaphragm. An expansion tank provides space for the water to expand as it is heated and assists in keeping the water pressure in the normal pressure range while the water heater is operating. These have been required in certain areas for new installations or replacement since 2012.

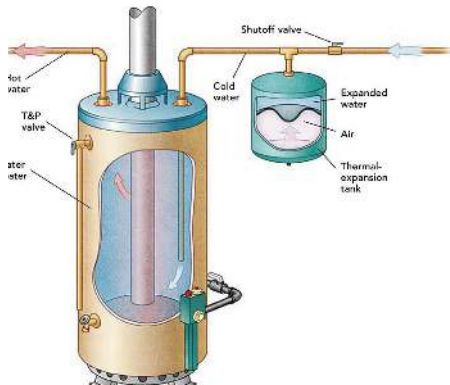

Water Heater: TPR valve

At water heater

Adequate, Present

The TPR valve's job is to vent off excess pressure when water pressure is greater than 150 PSI or water temperature exceeds 210 degrees Fahrenheit. When the valve opens it discharges scalding hot water through the overflow tube. Your homeowner's insurance may cover water damage but that may be negated if the policy requires a licensed plumber to install a water heater, as many policies do.

Furthermore water heater warranties of many manufacturers will be voided if the installation is not done by a licensed plumber. Water heater manufacturers require the installing plumber's license number to register the product warranty. For safety reasons, It is recommended that the installation of this water heater be verified with the seller prior to settlement.

Water Heater: Water Heater Maintenance

Water Heater

The serviceable life of most water heaters is 15-20 years. They should be flushed annually to prevent sediment buildup and maintain efficiency. I recommend a qualified plumber service and flush.

[Here is a DIY link to help](#)

[Water Heater Tanks](#)

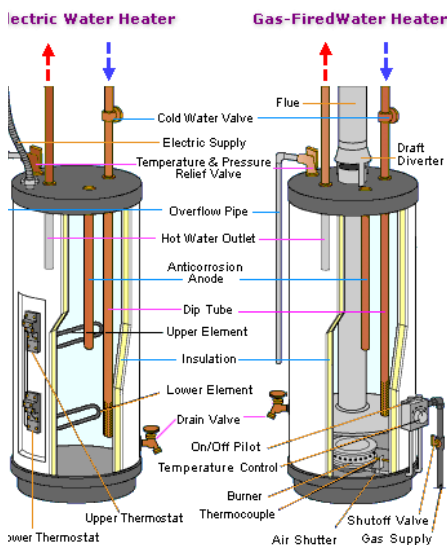

Sump Pumps: General

Not present

The inspector will report on the condition of a sump pump or sewer ejector present that is readily accessible. He will not open sump or sewage ejector covers that are sealed or bolted shut. He will attempt to operate the sump pump and/or sewage ejector to determine if it is functional at the time of inspection and report the results. If no water is in the sump pit and the pump motor works I recommend a qualified professional to test the motor with water in the pit. Specific visible defects will be commented in this report. The pictures provided below are for informational use.

[Sump pump maintenance](#)

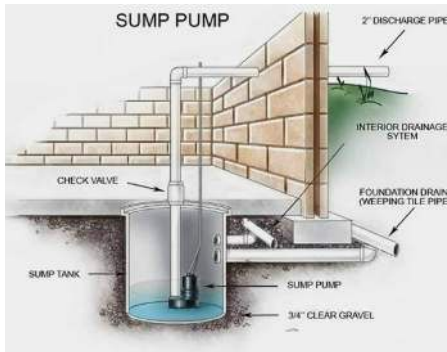

Fuel Supply, Storage & Distribution Systems: Fuel Distribution

Copper

The inspector will call out the type of fuel supply piping. If the system is not properly bonded a comment will be made in this section of the report.

Fuel Supply, Storage & Distribution Systems: Fuel Storage/Supply

Propane Tank

The condition of the interior gas lines, oil tanks and their supply lines, propane tanks and their supply lines or other forms of fuel storage and supply are not part of the home inspection and was not evaluated.



Limitations

Water Supply

HIDDEN LINES NOT INSPECTED

WHOLE HOUSE

Water distribution, drain, and vent lines that are underground, hidden behind walls or in floors are not visible and will not be inspected.

Water Supply

PLUMBING SYSTEM

The plumbing system of the home was inspected and reported on with the above information. While the inspector makes every effort to find all areas of concern, some areas can go unnoticed. Access panels to plumbing areas were not removed and the inspection was only visual. Any valves or piping not visually accessible were not inspected. For example, bathroom plumbing connections behind fastened access panels were not inspected. Please be aware that the inspector has your best interest in mind. Any repair items mentioned in this report should be considered before purchase. It is recommended that qualified contractors be used for your further inspection or repair issues as it relates to the comments in this inspection report.

Water Supply

ABANDONED WELL

EXTERIOR REAR

At the time of inspection I observed in an abandoned well. If this well would ever be reactivated a qualified plumber should evaluate and test the well.



Water Supply

WELL

If the home was equipped with an on-site well the ASHI Standards of Practice do not include the inspection of a well it's supply, pressure or operation. Since a well is the main source of water for the home it is an important component. I recommend consulting a professional to evaluate and service this component.

If you would like water testing or well flow test Precise Inspecting can perform these tests.

Water Distribution lines

IRRIGATION SYSTEMS

The inspection of an irrigation system, if present, is out of the scope of a home inspection and is not required by the ASHI inspections Standards of Practice.

Water Distribution lines

INACCESSIBLE PIPES AND DRAINS

****Important Note**** At the time of the inspection, some of the water supply lines and drain lines were inaccessible due to stored items and/or wall and ceiling coverings. Especially in areas under sinks and in basement ceilings and crawl spaces. The inspector made an effort to inspect these drains and water lines without moving household items or fixed components. It was not possible to inspect these lines and hidden damage may exist.

Drain, Waste, & Vent Systems

CAST IRON DRAIN CAUTION

BASEMENT

Where visible and invisible cast iron drain lines are present in the home's drain system they present a potential problem. These drains are older and may be hidden behind walls or under floors or in crawlspace.

Cast iron typically rusts from the inside out therefore its condition cannot be fully determined by a visual home inspection. Leakage that was not present or visible at the time of the inspection may occur when the home is occupied and water usage increases.

1. If usage (volume of waste water) of these drain lines increases when a new owner moves in, leaks can develop that were not present at the time of inspection.
2. If a home is vacant for 6 months or more, the inside of the cast iron can dry out and become detached from the drain wall. When water is introduced back into the drain lines the dry cast iron pieces can become detached from the drain line walls and clog the system.

Because of this, and other factors associated with cast iron, I recommend a qualified professional to inspect the cast iron lines prior to settlement and to consider a video scope of the entire line all the way to the public connection.

[Common Cast Iron Pipe Problems](#)

Comments

9.6.1 Water Heater

ELECTRIC WATER HEATER NEARING END OF USEFUL LIFE

18 YEARS OLD

At the time of the inspection, the age of the electric water heater was approaching the end of its average useful life. Based on the manufacturer's suggested service life, the life expectancy of a water heater is about 10 to 18 years but can last longer. I recommend a qualified professional to evaluate in order to confirm its condition.

[Average Life of Water Heater](#)



Recommendations

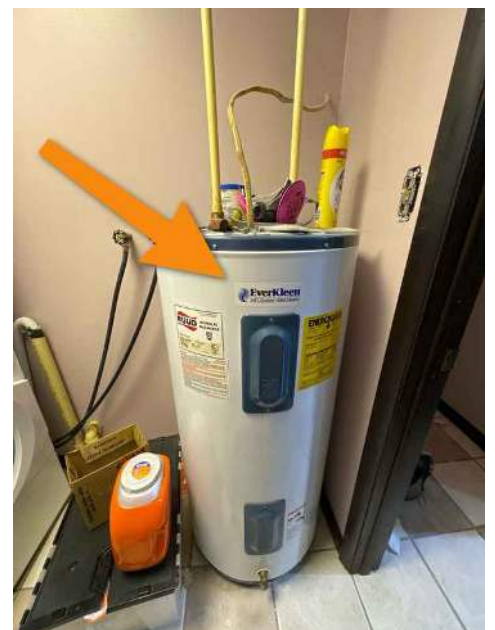

10: ELECTRICAL

		IN	NI	NP	C
10.1	General	X			
10.2	Main Distribution Panel	X			X
10.3	Branch Wiring	X			
10.4	Connected Devices and Fixtures	X			X
10.5	Receptacles	X			X
10.6	Switches	X			
10.7	Fire/CO Safety	X			X
10.8	Other electronic systems		X		

IN = Inspected NI = Not Inspected NP = Not Present C = Comments

Information

Main Distribution Panel: Over-current Protection
Breakers

Main Distribution Panel: Panel Capacity
200 AMP

Main Distribution Panel: Panel Disconnect
200 amp breaker at panel



General: Electrical system

Whole house

The electrical system of the home was inspected and reported on with the above information. While the inspector will make every effort to find all areas of concern, some areas may go unnoticed. Outlets and switches were not opened. The inspection was only visual. For example, any outlets, switches or fixtures not readily accessible (behind the refrigerator for example) was not inspected. Please be aware that the inspector has your best interest in mind and is seeking to provide an accurate assessment of the electrical system on the day of the inspection.

Any repair items mentioned in this report should be considered before settlement. As a home inspector, we do not inspect according to specific local or national codes as they differ between municipalities. It is recommended that the advice of a qualified electrician be used to supplement this inspection and to address any repair issues.

General: Life expectancy of residential electric systems

The electrical system of your home has a limited life span. Electricity delivers constant load (heat) to its component parts. This constant use will cause even the most quality materials to eventually fail. The NAHB (National Association of Home Builders) has published the following life expectancy estimates for the important parts of your home's electrical system.

- Main Panel - 60 years
- Wiring (copper) - 100 years
- Breakers - 30-40 years
- Receptacles/Switches - 30 years

For more info read: [Your home electrical system: how long can it last?](#)

Main Distribution Panel: Main Panel

Basement

Electrical panels are considered continuous-use appliances because they are always on. They experience daily heating and cooling of their components. As such, they should be replaced periodically. The average life of a panel is 30-50 years depending upon many factors. I recommend a qualified professional to evaluate this panel to determine if this panel should be updated to a newer panel.



Main Distribution Panel: Testing circuit breakers

When inspecting an electrical panel in an occupied house the inspector will not turn on any breakers that are in the off position.

When inspecting an electric panel in an unoccupied house the inspector will test all circuit breakers that are marked with the word test on the breaker.

Branch Wiring: Visible Branch Wiring

Copper, Non-metallic sheathed (Romex)

At the time of the inspection, the predominant, visible branch wiring appeared to be in good condition. Any visible defects will be listed separately in the report.

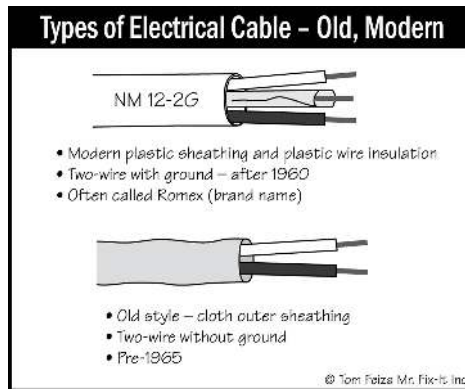

F043

Receptacles : AFCI protection

As of **2014**, AFCI protection is required on all branch circuits supplying outlets or devices installed in dwelling unit kitchens, family rooms, dining rooms, living rooms, parlors, libraries, dens, bedrooms, sunrooms, recreation rooms, closets, hallways, laundry areas, and similar rooms and areas.

Although AFCI protection may not have been required at the time the home was originally constructed, as general knowledge of safe building practices has improved with the passage of time, building standards have changed to reflect current understanding. The inspector recommends updating receptacles to provide AFCI protection where required. All work should be performed by a qualified professional.

Word of caution: it is not always possible to simply replace old breakers with new AFCI breakers in an older home due to original wire constraints.

Receptacles : GFCI protection

Ground Fault Circuit Interrupters or GFCI is a safety device that quickly breaks an electrical circuit to protect equipment and to reduce the risk of serious harm from an ongoing electric shock. Since 1973 these receptacles have slowly been introduced to the NEC (National Electric Code) as requirements in certain areas of the home.

[Here is a link](#) to read about how GFCI receptacles keep you safe.

In most municipalities, the GFCI requirement came about in the following time frame. (These dates represent approximate estimates based on all of the codes used nationally)

- 1973: exterior receptacles (less than 6 feet from the ground)
- 1976: bathroom receptacles
- 1980: garage receptacles*
- 1986: basements and kitchen receptacles within 6 feet of the sink.
- 1990: bath lighting, pools, and spas, crawl spaces, boat houses, hot tub equipment, all kitchen receptacles.

*It is not recommended that a refrigerator outlet in a garage be on a GFCI outlet

Fire/CO Safety: Smoke and CO detectors

Smoke detectors and CO detectors are a small but vital element in your home. They should be placed on every level of the home. Check with your municipality for specific locations. Batteries should be regularly checked and units should be replaced every 10 years.

Recommended reading: [Smoke Alarms](#)

Recommended reading: [Carbon Monoxide Detectors](#)

Recommended reading [NFPA - Smoke Alarm types](#)

The ASHI Standard of Practice requires the reporting of the presence or absence of smoke alarms and carbon monoxide alarms. The inspector will report on the presence or absence of these units. **There is no ASHI requirement to inspect, identify or test these alarms individually therefore I recommend a licensed professional to evaluate the floor plan and confirm that all necessary alarms are in working condition and confirm that they comply with the requirements of local municipalities.**

See limitations in this section

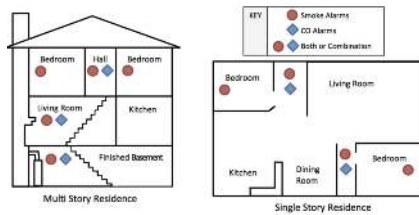

Illustration

Fire/CO Safety: Smoke Alarms

Missing smoke alarms, in 4 bedrooms

Safety -- The inspector shall comment on the presence or absence of smoke detectors in all required areas. To be effective, these detectors should be permanently mounted according to local codes and with appropriately operational batteries or hard wiring. I recommend the whole house be equipped with smoke detectors in the areas that are required by local municipality codes. A home inspection does not include testing the functionality of smoke or carbon monoxide detectors. Smoke Alarms



Fire/CO Safety: CO detectors

Missing CO detector, Outside bedrooms, Basement

Safety -- At the time of the inspection, carbon monoxide detectors were missing in areas most often recommended by municipalities. To be effective, these detectors should be permanently mounted according to local codes with appropriately operational batteries, or, hard wired. I recommend the local municipalities be consulted and carbon monoxide detectors be installed the recommended areas. CO Detectors

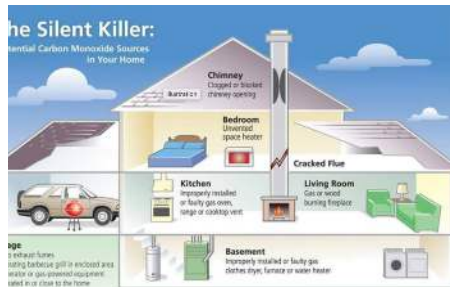

Suggested locations

Other electronic systems: Generator system

Exterior Right Side

I observed a generator system with associated panels and plugs. ASHI standards of practice do not include inspecting these systems. I recommend having a qualified specialist evaluate this system to confirm that it is functional and safe.



Limitations

Branch Wiring

NOT COMPLETELY VISIBLE

At the time of inspection not all of the branch wiring was able to be inspected due to lack of visibility. This could be because of wall/floor coverings, lack of access to main panel or stored items. I recommend a qualified professional to evaluate this wiring where access is provided, prior to settlement.

Comments

10.2.1 Main Distribution Panel

**SHARED NEUTRAL WIRES**

MAIN PANEL - 3 LOCATIONS

At the time of the inspection, I observed more than one neutral wire under one terminal (screw) on the neutral bar of the panel. Two neutral wires should not be connected to a single terminal in a panel board unless those terminals are specifically identified, NEC 110.14(A).

One reason this should not be done is so that the circuit can be isolated if it needs to be worked on.

Another reason is when two wires are under a single screw the heat generated by the electrical current causes these wires to expand and contract. The result is the connectors may come loose leading to arching and potentially to fire. The current installation is not up to industry standards.

While panel manufacturers will allow for up to three grounding conductors under a single lug, they typically only allow one neutral wire. The grounding conductors aren't going to normally carry current for extended periods of time, so they have a very slim possibility of coming loose. This isn't the case with the neutral conductors.

I recommend a professional to rewire the ground bar(s) and to add a separate neutral bar if necessary.

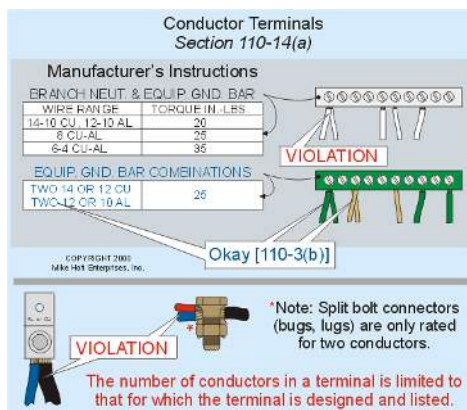
Shared neutral wires**Code specifications**

10.2.2 Main Distribution Panel

**MISSING(OVEN) KNOCKOUT(S)**

MAIN ELECTRICAL PANEL

I observed one or more open or improperly adapted electrical knockout(s) at the main panel. This presents an opportunity for accidental shocks, an opening for hot sparks to escape or an opening for pests to enter and cause damage to the wiring. I recommend a qualified professional to plug the knockout(s).

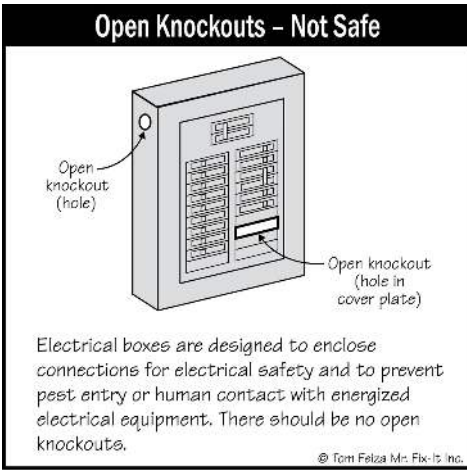

F134

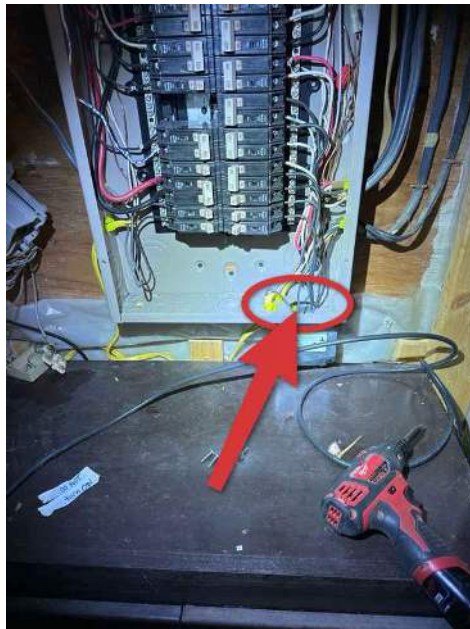

10.4.1 Connected Devices and Fixtures

Maintenance

MISSING FIXTURE

BASEMENT CLOSET

At the time of inspection, I observed one or more electric fixtures that were missing. I recommend a new fixture(s) be installed at this location.



10.5.1 Receptacles

Recommendations

GFCI OUTLET(S) PROTECTION MISSING

2 LOCATIONS

••**Safety Issue**•• GFCI protection was missing in one or more locations where Ground Fault protected outlets should be installed. A GFCI device protects against electric shocks from electrical devices used in damp areas of the home. Electrical Code may not have required these outlets at the time the house was constructed, however I recommend a licensed electrician upgrade these and other outlets to current standards. The pictured outlet(s) may only be representative. The inspector tested a representative number of receptacles.

[Here is a link](#) to read about how GFCI receptacles keep you safe.

In most municipalities, the GFCI requirement came about in the following time frame. (These dates represent approximate estimates based on all of the codes used nationally)

- 1973: exterior receptacles (less than 6 feet from the ground)
- 1976: bathroom receptacles
- 1980: garage receptacles*
- 1986: basements and kitchen receptacles within 6 feet of the sink.
- 1990: bath lighting, pools, and spas, crawl spaces, boat houses, hot tub equipment, all kitchen receptacles.
- Later code included laundry rooms

*It is not recommended that a refrigerator outlet in a garage be on a GFCI outlet

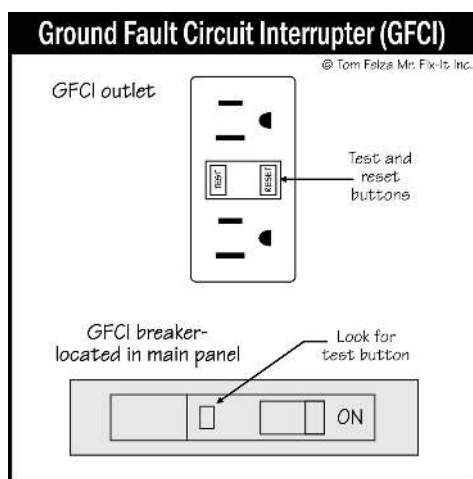

EC16
Illustration



Bathroom



Basement Bathroom

10.5.2 Receptacles

RECEPTACLE - COVER PLATE MISSING

RIGHT SIDE BASEMENT



Maintenance

••**Safety issue**•• -- I observed an electrical box(es) that had missing cover plate(s). This presents a shock hazard. I recommend replacing all missing cover plates.



10.7.1 Fire/CO Safety

RECOMMEND REPLACE ALL FIRE/CO SAFETY DEVICES

THROUGHOUT HOME

 Recommendations

****Safety Issue**** The American Society of Home Inspectors (ASHI) Standard of Practice (SOP) states 7.2 The inspector is NOT required to: A. inspect: 1. remote control devices. 2. or test smoke and carbon monoxide alarms, security systems, and other signaling and warning devices.

The actual testing of smoke and carbon monoxide alarms is beyond the scope of a general home inspection (see ASHI SOP above). Therefore, to ensure the safety of the occupants of the home, we recommend that all smoke alarms and carbon monoxide alarms are replaced or evaluated by a professional upon taking possession of the home.

Your home inspector will report on the presence or absence of smoke alarms and carbon monoxide alarms in their proper places throughout the home. We recommend upgrading to the recommended house map included below.

Because actual testing of smoke and CO alarms will not be performed I recommend that all smoke alarms and CO alarms present or absent **be professionally replaced or evaluated upon taking possession of the home.**

Why your home inspector does not test:

1. A simple test of the device's alarm button does not ensure it will operate properly in a fire. The button test will only confirm the alarm sound is working. Testing the alarm test button will not confirm its response to actual smoke. A smoke test is required to confirm the safe operation of each individual smoke alarm.
2. There are many differing types of smoke and CO Alarms with differing expiration dates. Unless installation records exist, it can be impossible to determine when devices were installed and therefore when they are required to be replaced. Manufacturers of these alarms require that they be replaced at regular intervals.
3. Battery-operated devices are rarely charged. Even if the batteries have some charge left, it can be very difficult to determine when they were installed and in need of replacement.
4. Newer WiFi-connected alarms cannot be verified without a connected app.
5. Some alarms are connected to a security system that alerts the fire company. If the fire company responds to a false alarm, they may charge a fee for the mishap.

Upon replacement, I recommend regular maintenance and testing to confirm ongoing operation.

The interconnectivity of smoke and CO alarms is an important feature that may or may not be enforced by local code compliance municipalities. I recommend consulting the advice of a professional.

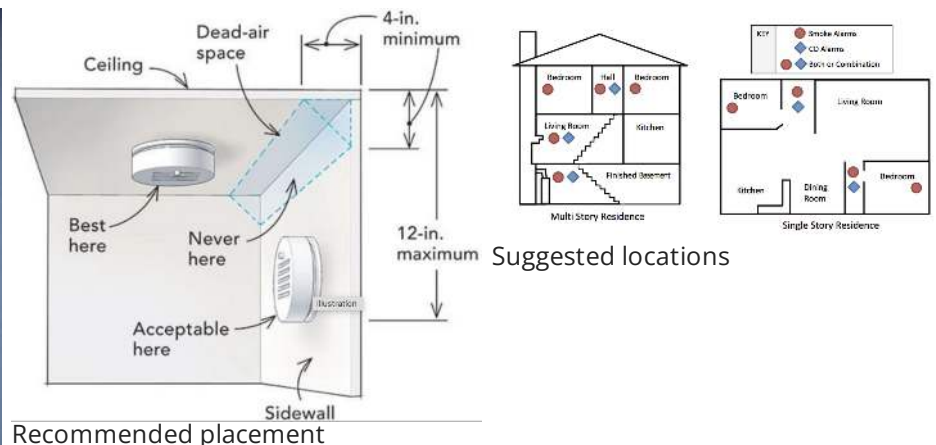

11: UTILITY LOCATIONS AND SHUT-OFFS

		IN	NI	NP	C
11.1	Electric	X			
11.2	Water	X			
11.3	Propane	X			

IN = Inspected NI = Not Inspected NP = Not Present C = Comments

Information

Propane: Propane shut-off

Exterior Right Side



Electric: Electric shut off

Basement

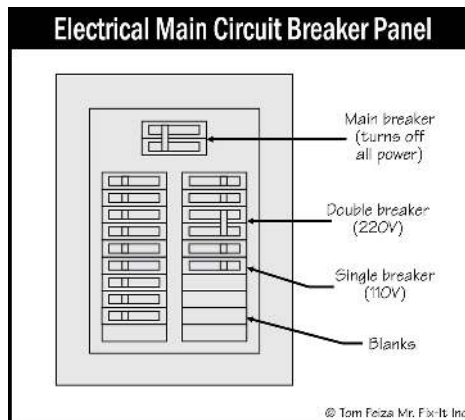

F002

Water: Water Shut-off

Basement

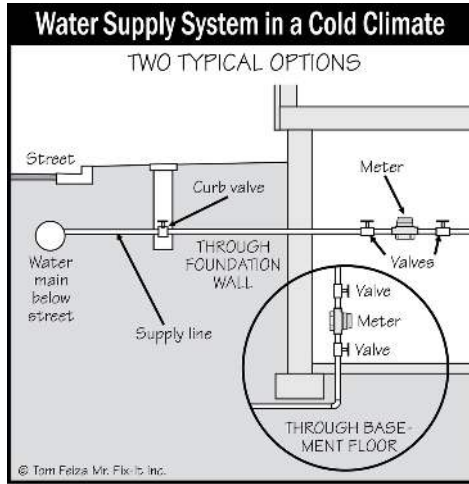

P005

12: BUILT-IN APPLIANCES

		IN	NI	NP	C
12.1	Dishwasher	X			
12.2	Refrigerator	X			
12.3	Garbage Disposal	X			
12.4	Range/Oven	X			
12.5	Microwave	X			
12.6	Washer/Dryer	X			X

IN = Inspected NI = Not Inspected NP = Not Present C = Comments

Information

Range/Oven: Energy Source

Electric

Range/Oven: Exhaust Hood Type

Re-circulate

Washer/Dryer: Dryer power source

110 Volt, 220 Electric

Life Expectancy of built-in appliances

Kitchen

Note: Life expectancy of built-in appliances varies with usage, installation, maintenance, and quality of materials. Appliances that are not built in (refrigerators, washers, dryers countertop microwaves etc) are not part of a standard home inspection. The link below includes a general guideline for life expectancy for common house appliances.

[InterNACHI's Standard Estimated Life Expectancy Chart for Homes](#)

Limits of built-in appliance inspection

Kitchen

A standard home inspection will inspect built-in appliances for basic fundamental operation. We do not inspect for performance. For example, we will not put garbage in the garbage disposal, dishes in the dishwasher, food in the oven or liquid in the microwave. For complete inspection limitations see Section 10 Interiors of the ASHI Standards of Practice.

Dishwasher: Dishwasher

The inspector will test the operation of the dishwasher using normal controls and report on its condition. Defects will be commented on separately.

Over time, a heavy film build-up from hard water minerals can become deposited on the inside walls and heating element of the dishwasher. After removing all of dishes, pans, silverware etc. and with no detergent in your dishwasher, the following should be done to remove the type of scale shown:

Mold: Place one tablespoon of bleach in your dishwasher and then run it for a full cycle.

Rust: Place about half of a small container of Tang brand orange-flavored drink mix and then run it for a regular cycle. The citric acid in the Tang helps to loosen hard water deposits and cleans the scale from your dishwasher.

Stains: Place a cupful of white vinegar in your dishwasher and then run it for a full cycle. An alternative to vinegar is baking soda.



Refrigerator: Refrigerator

Kitchen

Present

Refrigerators fall outside the parameters of a home inspection (See [ASHI SOP](#)) because they are considered an appliance that is not permanently installed (like a washer/dryer). Therefore, it was not inspected. The inspector will, however, address defects in plumbing or electricity that are related to the unit itself.

Important Note: refrigerators require adequate ventilation on the sides, top and rear.

Refrigerator Ventilation



Refrigerator: Water/Ice Supply Line

Not visible

Certain material (i.e. plastic) is subject to early failure which could result in significant water damage.

Garbage Disposal: Disposal

The inspector will test the operation of the disposal using normal controls and report on its condition. Defects will be commented on separately.



Range/Oven: Range/Oven

The inspector will test the operation of the range/oven using normal controls and report on its condition. Defects will be commented on separately.

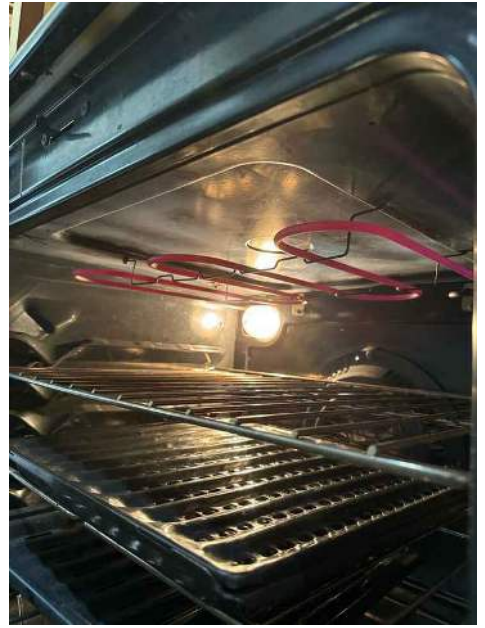

Microwave: Microwave

The inspector will test the operation of the microwave using normal controls and report on its condition. Defects will be commented on separately.



Washer/Dryer: W/D present, not inspected

At the time of the inspection there was a washer and dryer present. Inspecting washer and dryer operation is not within the scope of a home inspection.

**Comments**

12.6.1 Washer/Dryer

POTENTIAL LEAK

WASHING MACHINE

I observed a potential leak at the base of the washing machine. This water leak can cause significant damage if not repaired. I recommend a qualified professional to evaluate and repair.

 Material Defects



Washing machine may be leaking

13: SCOPE AND LIMITATIONS

Information

KEYS TO THE HOME INSPECTION

The home inspection or any portion thereof, was performed in accordance with the Standard of Practice and Code of Ethics of the American Society of Home Inspectors (ASHI). These standards are included in the report under each section summary. An earnest effort was made on your behalf to discover all visible defects, however, in the event of an oversight, maximum liability must be limited to two times the price of the home inspection. This inspection is an evaluation of the condition of the home in a period of time that is limited to several hours of investigation. It would take days to comprehensively evaluate the condition of a home.

Any areas that are not safe, readily accessible and/or visible to the inspector will not be included in the home inspection report. **The home inspection is not intended as a substitute for a Sellers Disclosure. This home inspection is not a compliance inspection or certification of any kind. It simply is an inspection of the condition of the home at the time of the inspection.** This inspection does not cover items or conditions that may be only discovered by invasive methods. No removal of materials or dismantling of systems shall be performed under this inspection. This is not a technically exhaustive inspection. The inspection report lists the systems and components inspected by Precise Inspecting, LLC. Items not found in this report are considered beyond the scope of the inspection and should not be considered inspected at this time.

Your home inspection is a snapshot in time. The defects found by Precise Inspecting during your inspection are the ones that were present at the time of the inspection. **All defects and recommendations in this report should be evaluated by a licensed professional prior to settlement so that repairs can be made. If this is not done existing defects may persist and increased damage may result.**

While we do your best to identify potential future problems and suggest preventive measures, you will experience future issues in the house that cannot be predicted by your inspection. Furthermore, your home inspection will only cover a representative sample. That means not every outlet or window or faucet will be checked.

This report contains technical information that may not be readily understandable to the lay person. Therefore, a verbal consultation with the inspector is an important part of this inspection. If you choose not to consult with your inspector, Precise Inspecting, LLC cannot be held liable for your understanding or misunderstanding of this reports contents. If you were not present during this inspection, please call the office at (717-808-5997) to arrange for your verbal consultation.

INSPECTION CATEGORIES

1) Maintenance Items - Primarily comprised of small cosmetic items and handyman maintenance items. These observations are more informational in nature and function as a future to-do list rather than something you might use as a negotiation or seller-repair item.

2) Recommendations - Most items typically fall into this category. These observations usually require a qualified contractor to evaluate further, in order to determine if repairs or replacements are necessary. Also included in this category are mechanical and structural systems that are nearing the end of their useful life but are still working. Items in this category may or may not enter into negotiations. Please consult your real estate agent.

3) Defects - This category is composed of "material defects" (as defined by the state of Pennsylvania). These defects normally enter into the negotiation phase of the home sale. They consist of systems, structures or components that are broken, not working as intended, not installed properly, of immediate safety concern or have a significant adverse impact on the value of the property. These items should be addressed by a qualified contractor as soon as possible.

Limitations - This section is not a category. It is a "**tabbed heading**" within each general section which describes any limiting factors that may be present on the day of the inspection. These can best be described as a circumstance or condition that makes it difficult or impossible to conduct a normal inspection of the area, component or system. For example: snow on the roof. The specific limitation will be described and in some cases pictures will be added. These limitations are in addition to the standard limitations that affect all home inspections and are described in the [ASHI SOP](#).

NOTICE: CODES AND REGULATIONS

Home inspections are not code inspections. The report is based on an examination of the visible portion of the structure at the time of the inspection with a focus on safety and function, not on current building or municipality codes.

While many home defects have roots in code compliance, we are not qualified to inspect to specific building codes. It is always recommended to check with the Building and Codes Department of your local township or municipality for permit information and code requirements when there is a question regarding the proper construction methods or code requirements for a particular defect present in the home.

NOTICE TO THIRD PARTIES OR OTHER PURCHASERS

Receipt of this report by any purchasers of this property other than the party(ies) identified on the cover page of this report, as the buyer, is not authorized by the inspector. Liability under this report is limited to the party identified on the cover page of this report as the buyer.

THIS REPORT IS NOT A WARRANTY

This report is not a home warranty. It is recommended that a home warranty be purchased prior to the purchase of the home in the event that any defects arise after the inspection and purchase. The report is based on an examination of the visible portion of the structure at the time of the inspection with a focus on safety and function, not on current building or municipality codes. Structure and mechanical parts of the house can and will change after the inspection and Precise Inspecting is not responsible for these changes or their effects. Any and all evaluations and recommendations made by Precise Inspecting, LLC should be carried out prior to closing. We recommend that you and/or your representative carry out a final walk-through inspection immediately before closing to check the condition of the property.

Furthermore, receipt of this report by any purchasers of this property other than the party(ies) identified on the cover page of this report is not authorized by the inspector. The inspector strongly advises against any reliance on this report by such party(ies). We recommend that you retain a qualified home inspector to provide you with your own inspection and report on this property. Liability under this report is limited to the party identified on the cover page of this report. The Home Inspection and the Inspection Report do not constitute and shall not be considered to be a warranty, either expressed or implied, concerning the present or future condition of the Property, the presence or absence of latent or hidden defects that are not reasonably ascertainable in a competently performed home inspection, or the remaining useful life of any system or component of the property. This report is not binding unless the pre-inspection agreement has been signed by the client and returned to Precise Inspecting, LLC along with payment of the inspection fee.

THE LIMITS OF A HOME INSPECTION

A home inspection is a visual examination of the home's physical structure and systems. Because we can only inspect what we can see, we cannot account for anything hidden from view. Such things include but are not limited to those that are obstructed by furniture or personal belongings, including things behind walls or below ground.

Some examples of note would be any and all interior and exterior plumbing drain lines and roof, gutter and perimeter drainage systems that are underground or otherwise hidden. I recommend these systems and lines be evaluated by a qualified professional prior to settlement in the event that hidden damage may exist.

In addition, there are numerous items, systems, and areas that are **not included** in the scope of this inspection as provided by the [ASHI Standards of Practice](#). It is **important** that you take time to **read** and understand these limitations as they will affect the completed inspection report.

PER PENNSYLVANIA STATE ACT 2000-114:

A home inspection as defined by Pennsylvania law is "A non-invasive, visual examination of some combination of the mechanical, electrical or plumbing systems or the structural and essential components of a residential dwelling designed to identify material defects in those systems and components, and performed for a fee in connection with or preparation for a proposed or possible residential real estate transfer. The term also includes any consultation regarding the property that is represented to be a home inspection or that is described by any confusingly similar term. The term does not include an examination of a single system or component of a residential dwelling such as, for example, its electrical or plumbing system or its roof. The term also does not include an examination that is limited to inspection for, or of, one or more of the following; wood destroying insects, underground tanks and wells, septic systems, swimming pools and spas, alarm systems, air and water quality, tennis courts and playground equipment, pollutants, toxic chemicals and environmental hazards." A home inspection is intended to assist in evaluation based on observation of the visible and apparent condition of the structure and its components on the date of inspection. The results of this home inspection are not intended to make any representation regarding the presence or absence of latent or concealed defects that are not reasonably ascertainable in a competently performed home inspection. No warranty or guaranty is expressed or implied. If the person conducting your home inspection is not a licensed structural engineer of the overall condition of the dwelling. The inspection is not a professional whose license authorizes the rendering of opinion as to the structural integrity of a building or its other component parts, you may be advised to seek a professional opinion as to any defects or concerns mentioned in the report. This home inspection report is not to be construed as an appraisal and may not be used as such for any purpose.

14: ENVIRONMENTAL CONCERNS

Information

Asbestos

Asbestos is a fibrous material that was used in many building materials. The asbestos fibers can cause cancer and other types of lung disease if inhaled. Asbestos can only be identified by laboratory analysis, therefore its identification is beyond the scope of the inspection. Asbestos was banned entirely in the United States in 1978. For further information regarding asbestos please visit www.epa.gov/asbestos.

Lead Paint (prior to 1978):

Lead-based paint was common in use until about 1974. According to the Federal Department of Housing and Urban Development, a lead hazard can be present in a house built on or before 1978. It is believed that the primary danger would be to small children who may somehow ingest chips of lead-based paint. For further information regarding lead-based paint please visit www.hud.gov/offices/lead.

Mold

This inspection is not an inspection for mold. Mold, mildew and indoor or outdoor air quality concerns can be found in many environments and may be especially prevalent in the home. If the home inspection report discloses evidence of moisture or water penetration, whether active or inactive, mold may be present within the property. The identification or detection of any mold, mildew and/or indoor/outdoor air quality is beyond the scope of the inspection **unless a specific request for IAQ or mold screening is requested, a contract signed and a fee paid to Precise Inspecting, LLC**. This company cannot and will not offer any representations, guarantees or warranties of any kind, written or oral, that the property is free from any mold, mildew and/or indoor/outdoor air quality concerns. Inspection for mold, mildew and/or indoor/outdoor air quality should be performed, detected and evaluated by a specialist of the customer's choice or by Precise Inspecting, LLC. For further information regarding mold please visit www.epa.gov/mold.

Radon Gas

Radon gas naturally occurs in our environment. Radon gas is a class A carcinogen and is the second leading cause of lung cancer, after smoking. The U.S. Environmental Protection Agency (EPA) and the Surgeon General strongly recommend taking further action when the home's radon test results are 4.0 pCi/L or greater. The national average indoor radon level is about 1.3 pCi/L. The higher the home's radon level the greater the health risk to you and your family. Reducing your radon levels can be done easily, effectively and fairly inexpensively. Even homes with very high radon levels can be reduced below 4.0 pCi/L. For further information about radon please visit www.epa.gov/radon. The EPA and Precise Inspecting LLC strongly recommends testing all homes for the presence of radon gas.

Urea Formaldehyde (Foam Insulation)

U.F.I. became popular as a residential retrofit insulation in the mid-1970's. It was banned in the U.S.A. in 1982, then the ban was lifted. Formaldehyde gas usually dissipates with time and proper ventilation. However, this gas is known to be a respiratory irritant, particularly to younger and older people. The EPA has not adopted any standards as to harmful levels of formaldehyde gas, however it does caution exposure. Note: various other countries consider exposure to this gas harmful in concentrations of one-fiftieth of the amounts considered safe by the EPA. Consult with your inspection service for additional information.

STANDARDS OF PRACTICE

Inspection Details

2.2 The *inspector* shall:

A. *inspect readily accessible*, visually observable, *installed systems and components* listed in this Standard. B. provide the client with a written report, using a format and medium selected by the *inspector*, that states: 1. those *systems and components* inspected that, in the professional judgment of the *inspector*, are not functioning properly, significantly deficient, *unsafe*, or are near the end of their service lives, 2. recommendations to correct, or monitor for future correction, the deficiencies reported in 2.2.B.1, or items needing *further evaluation* (Per Exclusion 13.2.A.5, the *inspector* is NOT required to determine methods, materials, or costs of corrections.), 3. reasoning or explanation as to the nature of the deficiencies reported in 2.2.B.1, that are not self-evident, 4. those *systems and components* designated for inspection in this Standard that were present at the time of the *home inspection* but were not inspected and the reason(s) they were not inspected.

C. adhere to the ASHI Code of Ethics for the Home Inspection Profession.

2.3 This Standard is not intended to limit the *inspector* from:

A. including other services or *systems and components* in addition to those required in Section 2.2.A. B. designing or specifying repairs provided the *inspector* is appropriately qualified and willing to do so. C. excluding *systems and components* from the *inspection* if requested or agreed to by the client.

Roofing

5.1 The inspector shall: A. inspect: 1. roofing materials. 2. roof drainage systems. 3. flashing. 4. skylights, chimneys, and roof penetrations. B. describe: 1. roofing materials. 2. methods used to inspect the roofing.

5.2 The inspector is NOT required to inspect: A. antennas. B. interiors of vent systems, flues, and chimneys that are not readily accessible. C. other installed accessories.

Exterior

4.1 The inspector shall: A. inspect: 1. wall coverings, flashing, and trim. 2. exterior doors. 3. attached and adjacent decks, balconies, stoops, steps, porches, and their associated railings. 4. eaves, soffits, and fascias where accessible from the ground level. 5. vegetation, grading, surface drainage, and retaining walls that are likely to adversely affect the building. 6. adjacent and entryway walkways, patios, and drive-ways. B. describe wall coverings.

4.2 The inspector is NOT required to inspect: A. screening, shutters, awnings, and similar seasonal accessories. B. fences, boundary walls, and similar structures. C. geological and soil conditions. D. recreational facilities. E. outbuildings other than garages and carports. F. seawalls, break-walls, and docks. G. erosion control and earth stabilization measures.

Interiors

10.1 The inspector shall inspect: A. walls, ceilings, and floors. B. steps, stairways, and railings. C. countertops and a representative number of installed cabinets. D. a representative number of doors and windows. E. garage vehicle doors and garage vehicle door operators. F. installed ovens, ranges, surface cooking appliances, microwave ovens, dishwashing machines, and food waste grinders by using normal operating controls to activate the primary function.

10.2 The inspector is NOT required to inspect: A. paint, wallpaper, and other finish treatments. B. floor coverings. C. window treatments. D. coatings on and the hermetic seals between panes of window glass. E. central vacuum systems. F. recreational facilities. G. installed and free-standing kitchen and laundry appliances not listed in Section 10.1.F. H. appliance thermostats including their calibration, adequacy of heating elements, self cleaning oven cycles, indicator lights, door seals, timers, clocks, timed features, and other specialized features of the appliance. I. operate, or confirm the operation of every control and feature of an inspected appliance.

Structural Components

3. STRUCTURAL COMPONENTS 3.1 The inspector shall: A. inspect structural components including the foundation and framing. B. describe: 1. the methods used to inspect under floor crawlspaces and attics. 2. the foundation. 3. the floor structure. 4. the wall structure. 5. the ceiling structure. 6. the roof structure.

3.2 The inspector is NOT required to: A. provide engineering or architectural services or analysis. B. offer an opinion about the adequacy of structural systems and components. C. enter under floor crawlspace areas that have less than 24 inches of vertical clearance between components and the ground or that have an access opening smaller than 16 inches by 24 inches. D. traverse attic load-bearing components that are concealed by insulation or by other materials.

Insulation and Ventilation

11.1 The inspector shall: A. inspect: 1. insulation and vapor retarders in un-finished spaces. 2. ventilation of attics and foundation areas. 3. kitchen, bathroom, laundry, and similar exhaust systems. 4. clothes dryer exhaust systems. B.

describe: 1. insulation and vapor retarders in unfinished spaces. 2. absence of insulation in unfinished spaces at conditioned surfaces.

11.2 The inspector is NOT required to disturb insulation.

Heating

8.1 The inspector shall: A. open readily openable access panels. B. inspect: 1. installed heating equipment. 2. vent systems, flues, and chimneys. 3. distribution systems. C. describe: 1. energy source(s). 2. heating systems.

8.2 The inspector is NOT required to: A. inspect: 1. interiors of vent systems, flues, and chimneys that are not readily accessible. 2. heat exchangers. 3. humidifiers and dehumidifiers. 4. electric air cleaning and sanitizing devices. 5. heating systems using ground-source, water-source, solar, and renewable energy technologies. 6. heat-recovery and similar whole-house mechanical ventilation systems. B. determine: 1. heat supply adequacy and distribution balance. 2. the adequacy of combustion air components.

Air Conditioning

9.1 The inspector shall: A. open readily openable access panels. B. inspect: 1. central and permanently installed cooling equipment. 2. distribution systems. C. describe: 1. energy source(s). 2. cooling systems.

9.2 The inspector is NOT required to: A. inspect electric air cleaning and sanitizing devices. B. determine cooling supply adequacy and distribution balance. C. inspect cooling units that are not permanently installed or that are installed in windows. D. inspect cooling systems using ground-source, water-source, solar, and renewable energy technologies.

Plumbing

6.1 The inspector shall: A. inspect: 1. interior water supply and distribution systems including fixtures and faucets. 2. interior drain, waste, and vent systems including fixtures. 3. water heating equipment and hot water supply systems. 4. vent systems, flues, and chimneys. 5. fuel storage and fuel distribution systems. 6. sewage ejectors, sump pumps, and related piping. B. describe: 1. interior water supply, drain, waste, and vent piping materials. 2. water heating equipment including energy source(s). 3. location of main water and fuel shut-off valves. 6.2 The inspector is NOT required to: A. inspect: 1. clothes washing machine connections. 2. interiors of vent systems, flues, and chimneys that are not readily accessible. 3. wells, well pumps, and water storage related equipment. 4. water conditioning systems. 5. solar, geothermal, and other renewable energy water heating systems. 6. manual and automatic re-extinguishing and sprinkler systems and landscape irrigation systems. 7. septic and other sewage disposal systems. B. determine: 1. whether water supply and sewage disposal are public or private. 2. water quality. 3. the adequacy of combustion air components. C. measure water supply flow and pressure, and well water quantity. D. fill shower pans and fixtures to test for leaks.

Electrical

7.1 The inspector shall: A. inspect: 1. service drop. 2. service entrance conductors, cables, and raceways. 3. service equipment and main disconnects. 4. service grounding. 5. interior components of service panels and subpanels. 6. conductors. 7. overcurrent protection devices. 8. a representative number of installed lighting fixtures, switches, and receptacles. 9. ground fault circuit interrupters and arc fault circuit interrupters. B. describe: 1. amperage rating of the service. 2. location of main disconnect(s) and subpanels. 3. presence or absence of smoke alarms and carbon monoxide alarms. 4. the predominant branch circuit wiring method.

7.2 The inspector is NOT required to: A. inspect: 1. remote control devices. 2. or test smoke and carbon monoxide alarms, security systems, and other signaling and warning devices. 3. low voltage wiring systems and components. 4. ancillary wiring systems and components not a part of the primary electrical power distribution system. 5. solar, geothermal, wind, and other renewable energy systems. B. measure amperage, voltage, and impedance. C. determine the age and type of smoke alarms and carbon monoxide alarms.

Built-in Appliances

13.1 The inspector shall inspect: F. **installed** ovens, ranges, surface cooking appliances, microwave ovens, dishwashing machines, and food waste grinders by using normal operating controls to activate the primary function.

13.2 The inspector is NOT required to inspect:

- installed and free standing kitchen and laundry appliances not listed in Section 13.1.
- appliance thermostats including their calibration,
- adequacy of heating elements,
- self-cleaning oven cycles,
- indicator lights,
- door seals,
- timers, clocks, timed features, and other specialized features of the appliance.
- operate, or control the operation of every control and feature of an inspected appliance.

Scope and Limitations

General limitations

A. The inspector is NOT required to perform actions, or to make determinations, or to make recommendations not

specifically stated in this Standard.

B. Inspections performed using this Standard:

1. are not technically exhaustive.
 2. are not required to identify and to report:
 - a. concealed conditions, latent defects, consequential damages, and
 - b. cosmetic imperfections that do not significantly affect a components performance of its intended function.
- C. This Standard applies to buildings with four or fewer dwelling units and their attached and detached garages and carports.
- D. This Standard shall not limit or prevent the inspector from meeting state statutes which license professional home inspection and home inspectors.
- E. Redundancy in the description of the requirements, limitations, and exclusions regarding the scope of the home inspection is provided for emphasis only.

13.2 General exclusions

A. The inspector is NOT required to determine:

1. the condition of systems and components that are not readily accessible.
2. the remaining life expectancy of systems and components.
3. the strength, adequacy, effectiveness, and efficiency of systems and components.
4. the causes of conditions and deficiencies.
5. methods, materials, and costs of corrections.
6. future conditions including but not limited to failure of systems and components.
7. the suitability of the property for specialized uses.

ASHI Standard of Practice for Home Inspections Effective March 1, 2014

This supersedes all previous ASHI Standard of Practice for Home Inspections versions.

Copyright 2014 American Society of Home Inspectors, Inc. All rights reserved. 5.

The Standard of Practice for Home Inspections and Code of Ethics of the American Society of Home Inspectors

8. compliance of systems and components with past and present requirements and guidelines (codes, regulations, laws, ordinances, specifications, installation and maintenance instructions, use and care guides, etc.).

9. the market value of the property and its marketability.
10. the advisability of purchasing the property.
11. the presence of plants, animals, and other life forms and substances that may be hazardous or harmful to humans including, but not limited to, wood destroying organisms, molds and mold-like substances.
12. the presence of environmental hazards including, but not limited to, allergens, toxins, carcinogens, electromagnetic radiation, noise, radioactive substances, and contaminants in building materials, soil, water, and air.
13. the effectiveness of systems installed and methods used to control or remove suspected hazardous plants, animals, and environmental hazards.
14. operating costs of systems and components.
15. acoustical properties of systems and components.
16. soil conditions relating to geotechnical or hydrologic specialties.
17. whether items, materials, conditions and components are subject to recall, controversy, litigation, product liability, and other adverse claims and conditions.

B. The inspector is NOT required to offer:

1. or to perform acts or services contrary to law or to government regulations.
2. or to perform architectural, engineering, contracting, or surveying services or to confirm or to evaluate such services performed by others.
3. or to perform trades or professional services other than home inspection.
4. warranties or guarantees.

C. The inspector is NOT required to operate:

1. systems and components that are shut down or otherwise inoperable.
2. systems and components that do not respond to normal operating controls.
3. shut-off valves and manual stop valves. 4. automatic safety controls.

6. ASHI Standard of Practice for Home Inspections Effective March 1, 2014

This supersedes all previous ASHI Standard of Practice for Home Inspections versions.

D. The inspector is NOT required to enter:

1. areas that will, in the professional judgment of the inspector, likely be dangerous to the inspector or to other persons, or to damage the property or its systems and components.

2. under-floor crawlspaces and attics that are not readily accessible.

E. The inspector is NOT required to inspect:

1. underground items including, but not limited to, underground storage tanks and other underground indications of their presence, whether abandoned or active.
2. items that are not installed.
3. installed decorative items.
4. items in areas that are not entered in accordance with 13.2.D.
5. detached structures other than garages and carports.
6. common elements and common areas in multi-unit housing, such as condominium properties and cooperative housing.
7. every occurrence of multiple similar components.

8. outdoor cooking appliances.

F. The inspector is NOT required to:

1. perform procedures or operations that will, in the professional judgment of the inspector, likely be dangerous to the inspector or to other persons, or to damage the property or its systems or components.
2. describe or report on systems and components that are not included in this Standard and that were not inspected.
3. move personal property, furniture, equipment, plants, soil, snow, ice, and debris.
4. dismantle systems and components, except as explicitly required by this Standard.
5. reset, reprogram, or otherwise adjust devices, systems, and components affected by inspection required by this Standard.
6. ignite or extinguish fires, pilot lights, burners, and other open flames that require manual ignition.
7. probe surfaces that would be damaged or where no deterioration is visible or presumed to exist.